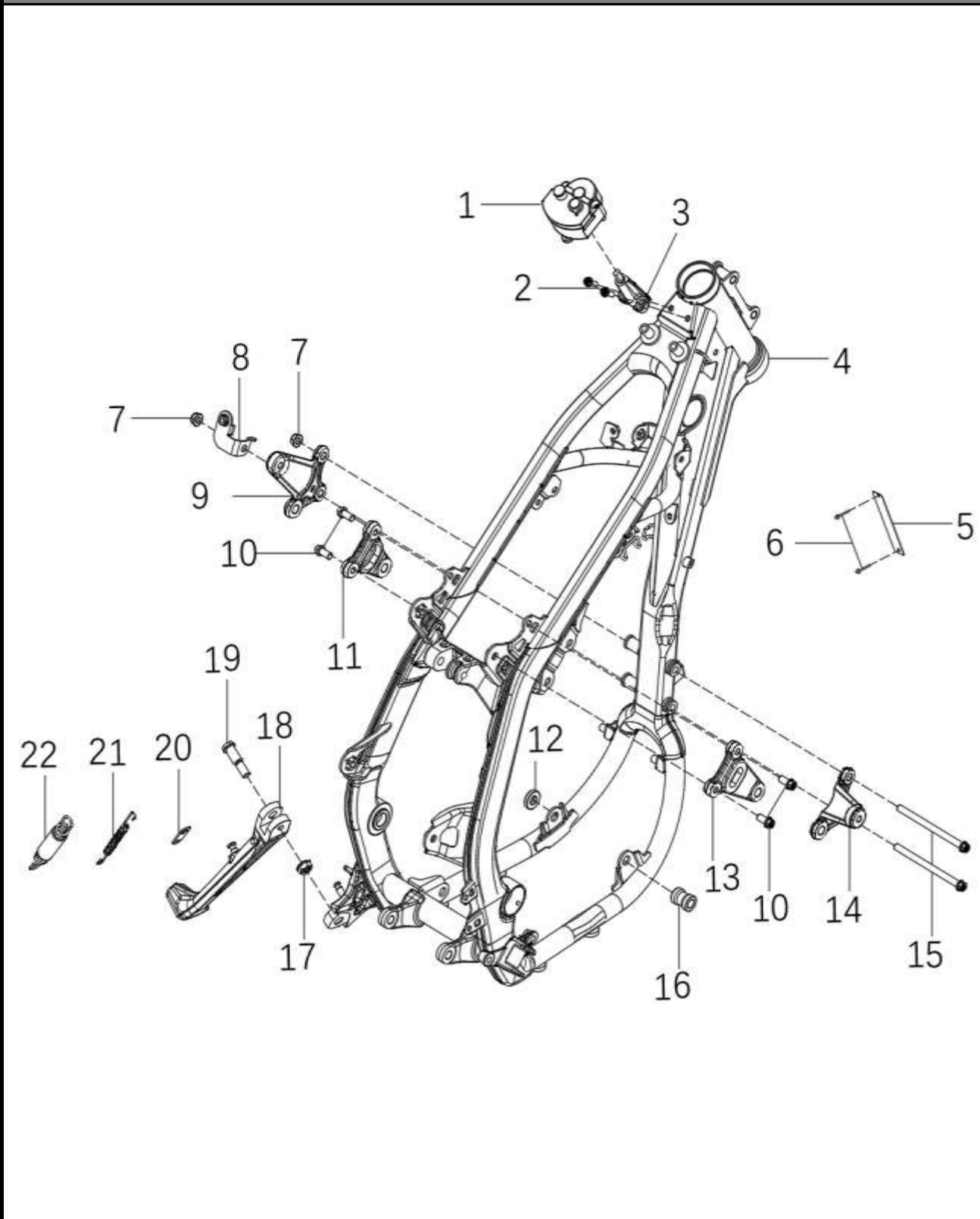
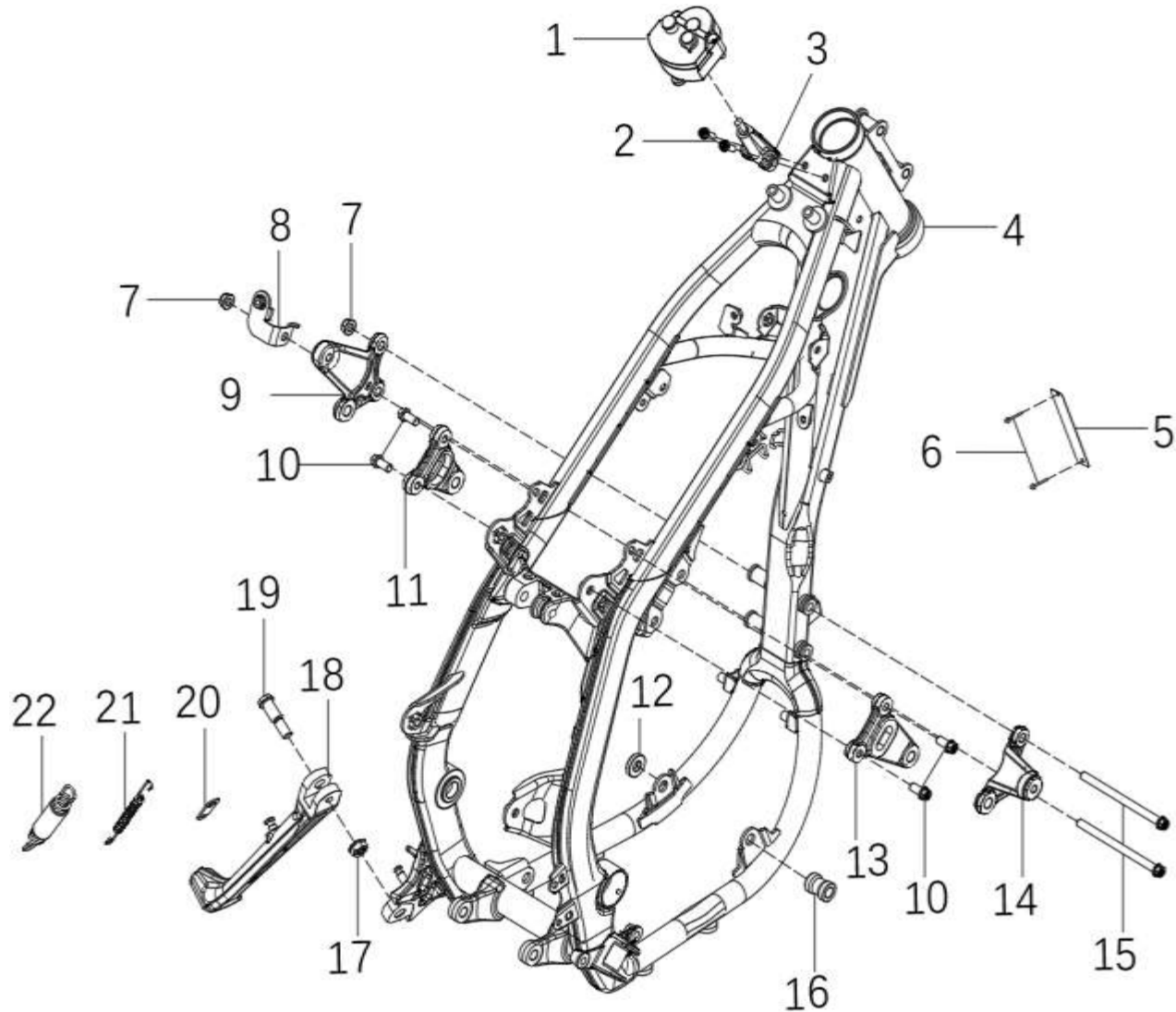

F-1 Frame Assy

PHOTO	NO.	Part CODE	Chinese/Chinese/English name and specification	UNIT
	1	380700-T501-00000	转向阻尼器 Steering dampers	PIECE
	2	5021-06016-BS00	内六花六角法兰面螺栓M6*16(盘11) Bolt, Hex. Flange M6x16 (Panhead 11)	PIECE
	3	380800-T501-00000	转向阻尼器调节座 Adjusting Block, Steering Damper	PIECE
	4	360006-T501-00000	车架焊接总成 Frame Assy	PIECE
	5	900001-R100-000	车架铭牌85*25 Frame nameplate 85*25	PIECE
	6	5015-03010-SC00	铆钉3.2*10 Rivet .2*10	PIECE
	7	5008-08085-SC00	六角法兰面自锁螺母M8*1.25 Tapping Nut, Hex. Flange M8*1.25	PIECE
	8	360077-T501-00000	喇叭支架 Horn Bracket	PIECE
	9	360037-T501-00000	发动机前悬挂-左 EngineFront Suspension - left	PIECE
	10	5021-08016-BS00	内六花六角法兰面螺栓M8*16(盘16) Bolt, Hex. Flange M8x16 (Panhead 16)	PIECE
	11	360039-T501-00000	发动机上悬挂-左 Engine upper suspension - left	PIECE
	12	910004-T501-00003	发动机下悬挂衬套-左 $\phi 10.5 * \phi 24 * 5$ Lower Engine Suspension Bushing-Left $\phi 10.5 * \phi 24 * 5$	PIECE
	13	360040-T501-00000	发动机上悬挂-右 Engine upper suspension - right	PIECE
	14	360038-T501-00000	发动机前悬挂-右 Engine front suspension-right	PIECE
	15	5021-08115-BS00	内六花六角法兰面螺栓M8*115(盘16) Bolt, Hex. Flange M8x115 (Panhead 16)	PIECE
	16	910004-T501-00002	发动机下悬挂衬套-右 $\phi 10.5 * \phi 20 * 26.5$ Lower Engine Suspension Bushing-Right $\phi 10.5 * \phi 20 * 26.5$	PIECE
	17	5008-10115-SC00	六角法兰面自锁螺母M10*1.25 Tapping Nut, Hex. Flange M10*1.25	PIECE
	18	370013-T501-00001	侧支架 Side Stand	PIECE
	19	5007-10042-BS00	侧支架专用螺栓M10*42.3 Bolt, Side Stand M10x42.3	PIECE
	20	360057-T501-00000	侧支架安装挂板 Side Stand mounting pendant plate	PIECE

F-1 Frame Assy-1

PHOTO	NO.	Part CODE	Chinese/Chinese/English name and specification	UNIT		
	21	360020-T501-00001	侧支架簧 ϕ 9.5, 线径1.6mm	Spring, Side Stand ϕ 9.5, Line Diameter 1.6mm	PIECE	
	22	360020-T501-00000	侧支架簧 ϕ 15*110, 线径2.5mm	Spring, Side Stand ϕ 9.5, Line Diameter 1.6mm	PIECE	
	23					
	24					
	25					
	26					
	27					
	28					
	29					
	30					
	31					
	32					
	33					
	34					
	35					
	36					
	37					
	38					
	39					
	40					

F-2 Steering column

PHOTO	NO.	Part CODE	Chinese/Chinese/English name and specification		UNIT	
	1	5001-14030-YH00	六角法兰面螺栓M14*1.5*30	Bolt, Hex. Flange M14*1.5*30	PIECE	
	2	5018-15010-SC00	平垫 $\phi 15 * \phi 33 * 1$	Washer, Flat $\phi 15 * \phi 33 * 1$	PIECE	
	3	5021-08035-BS00	内六花六角法兰面螺栓M8*35 (盘13)	Bolt, Hex. Flange M8x35 (Panhead 13)	PIECE	
	4	370020-T501-00000	上连接板	Connecting Plate, Upper	PIECE	
	5	350025-T501-00000	油管卡子	Oil pipe clip	PIECE	
	6	5021-08040-BS00	内六花六角法兰面螺栓M8*40 (盘13)	Bolt, Hex. Flange M8x40 (Panhead 13)	PIECE	
	7	370102-T501-00000	下连接板	Connecting Plate, Lower	PIECE	
	8	370101-T501-00000	方向柱	Steering Column	PIECE	
	9	5010-25100-YH00	4槽调节螺母M25*1.0*10*44	Nut, Adjustable 4 Groove M25*1.0*10*44	PIECE	
	10	371100-R100-00001	方向柱上防尘盖 $\phi 26mm * \phi 53mm$, 厚4.15	Upper Cap, Steering Column Anti-Dust $\phi 26mm * \phi 53mm$, THK: 4.15	PIECE	
	11	370600-R100-000	方向上轴承32005	Bearing, Steering Column Upper 32005	PIECE	
	12	370700-R100-000	方向下轴承32006E	Bearing, Steering Column Lower 32006E	PIECE	
	13	371200-R100-00001	方向柱下防尘盖 $\phi 30.2mm * \phi 61mm$, 厚5.06	Lower Cap, Steering Column Anti-Dust $\phi 30.2mm * \phi 61mm$, THK: 5.06	PIECE	
	14	5021-06012-BS00	内六花六角法兰面螺栓M6x12 (盘11)	Bolt, Hex. Flange M6x12 (Panhead 11)	PIECE	
	15					
	16					
	17					
	18					
	19					
	20					

F-3 Flat fork

PHOTO	NO.	Part CODE	Chinese/Chinese/English name and specification		UNIT
	1	5010-16110-BS00	前轮轴螺母M16*1.5	Nut, Front wheel axle M16*1.5	PIECE
	2	5103-303704-000	油封 $\phi 30*\phi 37*4$	Oil Seal $\phi 30*\phi 37*4$	PIECE
	3	910014-T501-00000	T型轴套 $\phi 17*\phi 22*40$	T-bush $\phi 17*\phi 22*40$	PIECE
	4	5106-223603-BS0	推力轴承 $\phi 22.2*\phi 36.5*3.6$	Thrust Bearing $\phi 22.2*\phi 36.5*3.6$	PIECE
	5	5102-222930-BS0	滚针轴承 $\phi 22*\phi 29*30$	Needle Bearing $\phi 22*\phi 29*30$	PIECE
	6	5103-222904-000	油封 $\phi 22*\phi 29*4$	Oil Seal $\phi 22*\phi 29*4$	PIECE
	7	420019-R201-000	平叉防尘盖	Rear Arm, Anti-dust	PIECE
	8	360300-T501-00000	平叉	Rear Arm	PIECE
	9	370011-T501-00000	链条调节器-左	Chain Adjuster (Left)	PIECE
	10	370012-T501-00000	链条调节器-右	Chain Adjuster (Right)	PIECE
	11	5008-08065-SC00	六角螺母M8	Bolt, Hex M8	PIECE
	12	5002-08055-BS00	六角螺栓M8*55	Hex Bolt M8*55	PIECE
	13	360026-T501-00000	导链器	Chain Guide	PIECE
	14	420059-T501-00000	导链器橡胶块	Rubber Blocks, Chain guide	PIECE
	15	420059-T501-00001	导链器橡胶块	Rubber Block, Chain guide	PIECE
	16	5005-06012-BS02	十字盘头螺钉M6*12(盘头直径10.5)	Screw, Cross-Shaped, Cup Head M6*12(Head diameter10.5)	PIECE
	17	420018-R100-000	链条护卡压板	Protecting Plate Press Plate, Chain	PIECE
	18	5021-06048-BS00	内六花六角法兰面螺栓M6*48(盘11)	Bolt, Hex. Flange M6x48 (Panhead 11)	PIECE
	19	5008-06070-SC00	六角法兰面螺母M6	Nut, Hex. Flange M6	PIECE
	20	5021-06012-BS00	内六花六角法兰面螺栓M6*12(盘11)	Bolt, Hex. Flange M6x12 (Panhead 11)	PIECE

F-3 Flat fork-1

PHOTO	NO.	Part CODE	Chinese/Chinese/English name and specification	UNIT	
	21	370017-T501-00000	链条护卡 Bolt, Hex. Flange	PIECE	
	22	410002-T501-00000	平叉轴 Axle, Rear Arm	PIECE	
	23	5018-17025-BS00	平垫 $\phi 17 * \phi 32 * 2.5$	Washer, Flat $\phi 17 * \phi 32 * 2.5$	PIECE
	24				
	25				
	26				
	27				
	28				
	29				
	30				
	31				
	32				
	33				
	34				
	35				
	36				
	37				
	38				
	39				
	40				

F-4 Rear shock absorber & Cradle

PHOTO	NO.	Part CODE	Chinese/Chinese/English name and specification		UNIT
	1	5021-10052-BS00	内六角六角法兰面螺栓M10*52	Bolt, Hex. Flange M10x52	PIECE
	2.1	371500-T501-00000	后减震器 (KYB减震)	Rear Shock Absorber (KYB Absorber)	PIECE
	2.2	371500-T501-00001	后减震器 (渝安减震)	Rear Shock Absorber (YU' AN Absorber)	PIECE
	3	5008-08085-SC00	六角法兰面自锁螺母M8*1.25	Tapping Nut, Hex. Flange M8*1.25	PIECE
	4	360800-T501-00000	导链轮总成	Guide Sprocket Assembly	PIECE
	5	5007-10061-BS00	导链轮螺栓M10*61	Guide Sprocket Bolt M10*61	PIECE
	6	5103-222804-000	油封 $\phi 22 * \phi 28 * 4$	Oil Seal $\phi 22 * \phi 28 * 4$	PIECE
	7	5013-10005-SC01	翻边衬套 $\phi 10.1 * \phi 22 * 5$	Bushing, Flange $\phi 10.1 * \phi 22 * 5$	PIECE
	8	5018-18015-BS00	平垫 $\phi 18 * \phi 27 * 1.5$	Washer, Flat $\phi 18 * \phi 27 * 1.5$	PIECE
	9	5102-172420-BS0	滚针轴承 $\phi 17 * \phi 24 * 20$	Needle Bearing $\phi 17 * \phi 24 * 20$	PIECE
	10	360008-T501-00001	U型摇架	U-shaped Rocker	PIECE
	11	910016-T501-00001	U型摇架轴套 $\phi 10 * \phi 17 * 87.5$	U-shaped Rocker Bushing $\phi 10 * \phi 17 * 87.5$	PIECE
	12	5001-10130-DK01	六角法兰面螺栓 M10*1.25*130	Bolt, Hex. Flange M10*1.25*130	PIECE
	13	5008-10115-SC00	六角法兰面自锁螺母M10*1.25	Tapping Nut, Hex. Flange M10*1.25	PIECE
	14	5103-172603-000	油封 $\phi 17.5 * \phi 26 * 3$	Oil Seal $\phi 17.5 * \phi 26 * 3$	PIECE
	15	360007-T501-00000	三角摇架	Triangle Rocker	PIECE
	16	910015-T501-00001	三角摇架轴套 $\phi 12 * \phi 20 * 37$	Triangle Rocker Bushing $\phi 12 * \phi 20 * 37$	PIECE
	17	910015-T501-00003	三角摇架轴套 $\phi 14 * \phi 19 * 10.2$	Triangle Rocker Bushing $\phi 14 * \phi 19 * 10.2$	PIECE
	18	910017-T501-00001	翻边轴承套 $\phi 10 * \phi 14 * 7.2$	Bushing, Flange $\phi 10 * \phi 14 * 7.2$	PIECE
19	5102-192613-BS0	滚针轴承 $\phi 19 * \phi 26 * 13$	Needle Bearing $\phi 19 * \phi 26 * 13$	PIECE	

F-4 Rear shock absorber & Cradle-1

PHOTO	NO.	Part CODE	Chinese/Chinese/English name and specification	UNIT
	20	5007-10045-BS00	扁头螺栓M10*45 Gib-headed Bolt M10*45	PIECE
	21	5007-12085-BS00	扁头螺栓M12*85 Gib-headed Bolt M12*85	PIECE
	22	5008-12125-SC00	六角法兰面自锁螺母M12*1.25 Tapping Nut, Hex. Flange M12*1.25	PIECE
	23	5103-253204-000	油封 $\phi 25 * \phi 32 * 4$ Oil Seal $\phi 25 * \phi 32 * 4$	PIECE
	24	5013-12005-BS00	翻边衬套 $\phi 12.1 * \phi 25 * 5$ Bushing, Flange $\phi 12.1 * \phi 25 * 5$	PIECE
	25	5018-20115-SC00	平垫 $\phi 20.1 * \phi 31 * 1.5$ Washer, Flat $\phi 20.1 * \phi 31 * 1.5$	PIECE
	26	5102-202615-BS0	滚针轴承 $\phi 20 * \phi 26 * 15$ Needle Bearing $\phi 20 * \phi 26 * 15$	PIECE
	27	910015-T501-00000	三角摇架轴套 $\phi 12 * \phi 20 * 61.5$ Triangle Rocker Bushing $\phi 12 * \phi 20 * 61.5$	PIECE
	28	5007-12105-BS00	扁头螺栓M12*105 Gib-headed Bolt M12*105	PIECE
	29			
	30			
	31			
	32			
	33			
	34			
	35			
	36			
	37			
	38			
	39			

F-5 Front net wheel

PHOTO	NO.	Part CODE	Chinese/Chinese/English name and specification	UNIT
	1	350027-T501-00000	前轮外胎 Front OuterTire	PIECE
	2	350042-T501-00000	前海绵胎 Front Sponge Tire	PIECE
	3	5021-06012-BS00	内六花六角法兰面螺栓M6*12(盘11) Bolt, Hex. Flange M6x12(Panhead 11)	PIECE
	4	351700-T501-00000	前碟刹盘 Brake Disc (Front)	PIECE
	5	350028-T501-00000	前轮垫带 Front Wheel Cushion	PIECE
	6	350039-T501-00000	前轮胎夹 Front Tyre Clip	PIECE
	7	352000-T501-00000	前网轮总成 Spoke WheelAssy, Front	PIECE
	8	410001-T501-00000	前轮轴(KYB减震器, 长度238) Axle, Wheel (Front) (KYB Shock Absorber, length 238)	PIECE
	9.1	410001-T501-00001	前轮轴(渝安减震器, 长度229) Axle, Wheel (Front) (Yu' an Shock Absorber, length229)	PIECE
	9.2	910012-T501-00002	前轮衬套-右 $\phi 20* \phi 27*13.5$ Bushing, Front Wheel (Right) $\phi 20* \phi 27*13.5$	PIECE
	10	910001-T500-00000	前轮衬套-左 Bushing, Front Wheel (Left)	PIECE
	11	5010-16110-BS00	前轮轴螺母M16*1.5 Nut, Front Axle M16*1.5	PIECE
	12	5103-273707-000	油封 $\phi 27* \phi 37*7$ Oil Seal $\phi 27* \phi 37*7$	PIECE
	13	5101-203709-BS0	轴承20*37*9 Bearing 20*37*9	PIECE
	14	910004-T501-00000	衬套 $\phi 20.3* \phi 27*71$ Collar $\phi 20.3* \phi 27*71$	PIECE
	15	350041-T501-00001	前轮速传感器支架 Bracket, Front Wheel Speed Sensor	PIECE
	16	5004-05008-BS00	内六花盘头螺钉M5*0.8*8 Screw, Inner Hex. Flat Head M5*8	PIECE
	17	350041-T501-00000	前轮速传感器支架 Bracket, Front Wheel Speed Sensor	PIECE
	18			
19				

F-6 Rear net wheel

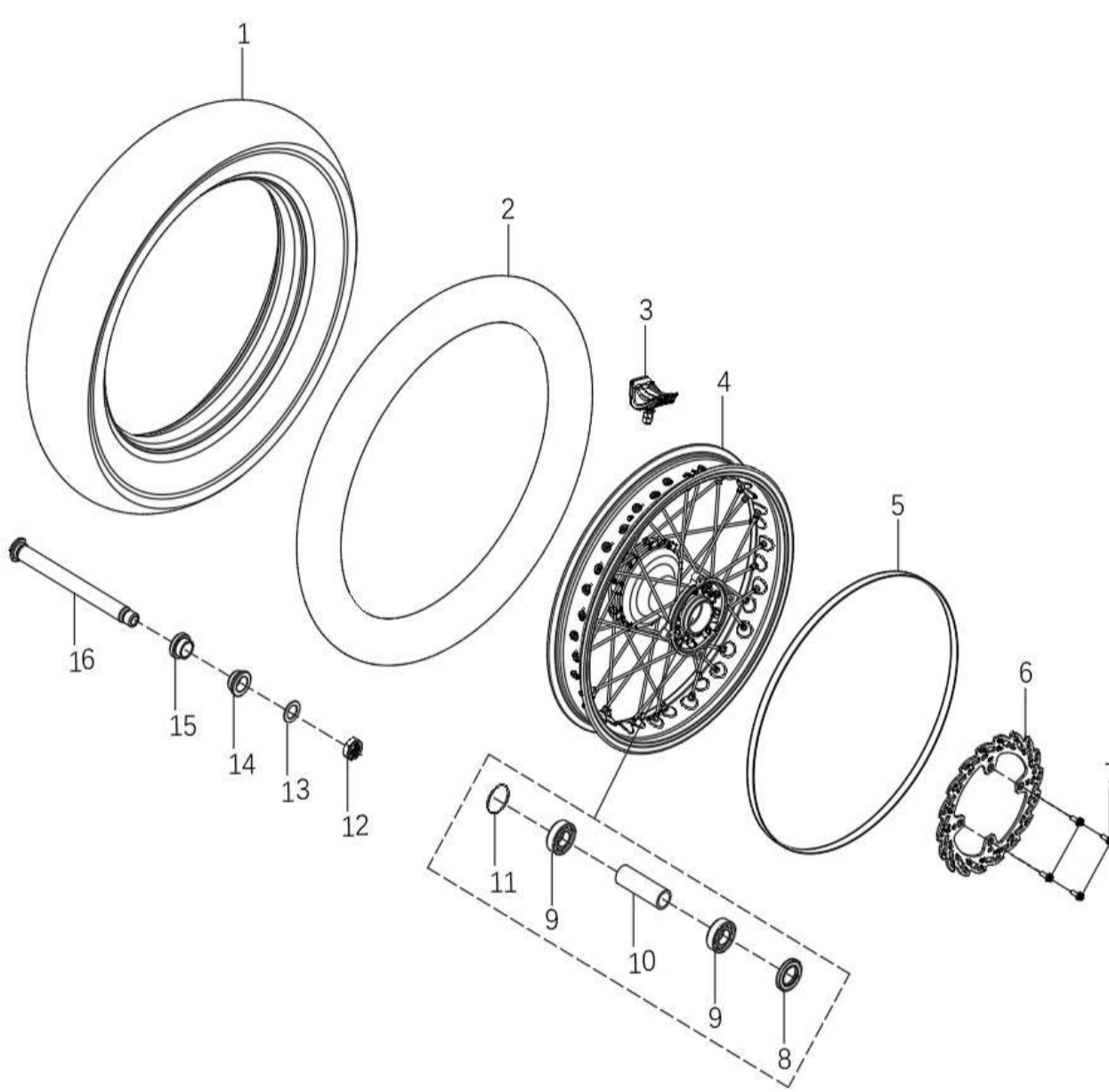
PHOTO	NO.	Part CODE	Chinese/Chinese/English name and specification	UNIT	
	1	350030-T501-00000	后轮外胎	Rear Wheel Outer Tire	PIECE
	2	350043-T501-00000	后海绵胎	Rear Sponge Tire	PIECE
	3	350040-T501-00000	后轮胎夹	Rear Tyre Clip	PIECE
	4	352100-T501-00000	后网轮总成	Spoke Wheel Assy, Rear	PIECE
	5	350031-T501-00000	后轮垫带	Rear Wheel Cushion	PIECE
	6	351800-T501-00000	后碟刹盘	Brake Disc (Rear)	PIECE
	7	5021-06016-BS00	内六花六角法兰面螺栓M6*16(盘11)	Bolt, Hex. Flange M6x16 (Panhead 11)	PIECE
	8	5103-325207-000	油封 $\phi 32 * \phi 52 * 7$	Oil Seal $\phi 32 * \phi 52 * 7$	PIECE
	9	5101-255215-BS0	轴承25*52*15	Bearing 25*52*15	PIECE
	10	910004-T501-00001	衬套 $\phi 25.3 * \phi 32 * 95$	Collar $\phi 25.3 * \phi 32 * 95$	PIECE
	11	5104-051020-000	O型圈 $\phi 51 * 2$	O-Ring $\phi 51 * 2$	PIECE
	12	5010-22125-SC00	后轮轴螺母M22*1.5	Nut, Wheel Axle (Rear) M22*1.5	PIECE
	13	5018-22520-BS00	平垫 $\phi 22.5 * \phi 35 * 2$	Washer, Flat $\phi 22.5 * \phi 35 * 2$	PIECE
	14	910003-T500-00000	后轮衬套-右	Bushing, Rear Wheel (Right)	PIECE
	15	910002-T500-00000	后轮衬套-左	Bushing, Rear Wheel (Left)	PIECE
	16	410003-T501-00000	后轮轴	Axle, Wheel (Rear)	PIECE
	17				
	18				
	19				
	20				

F-7 Engine lower guard

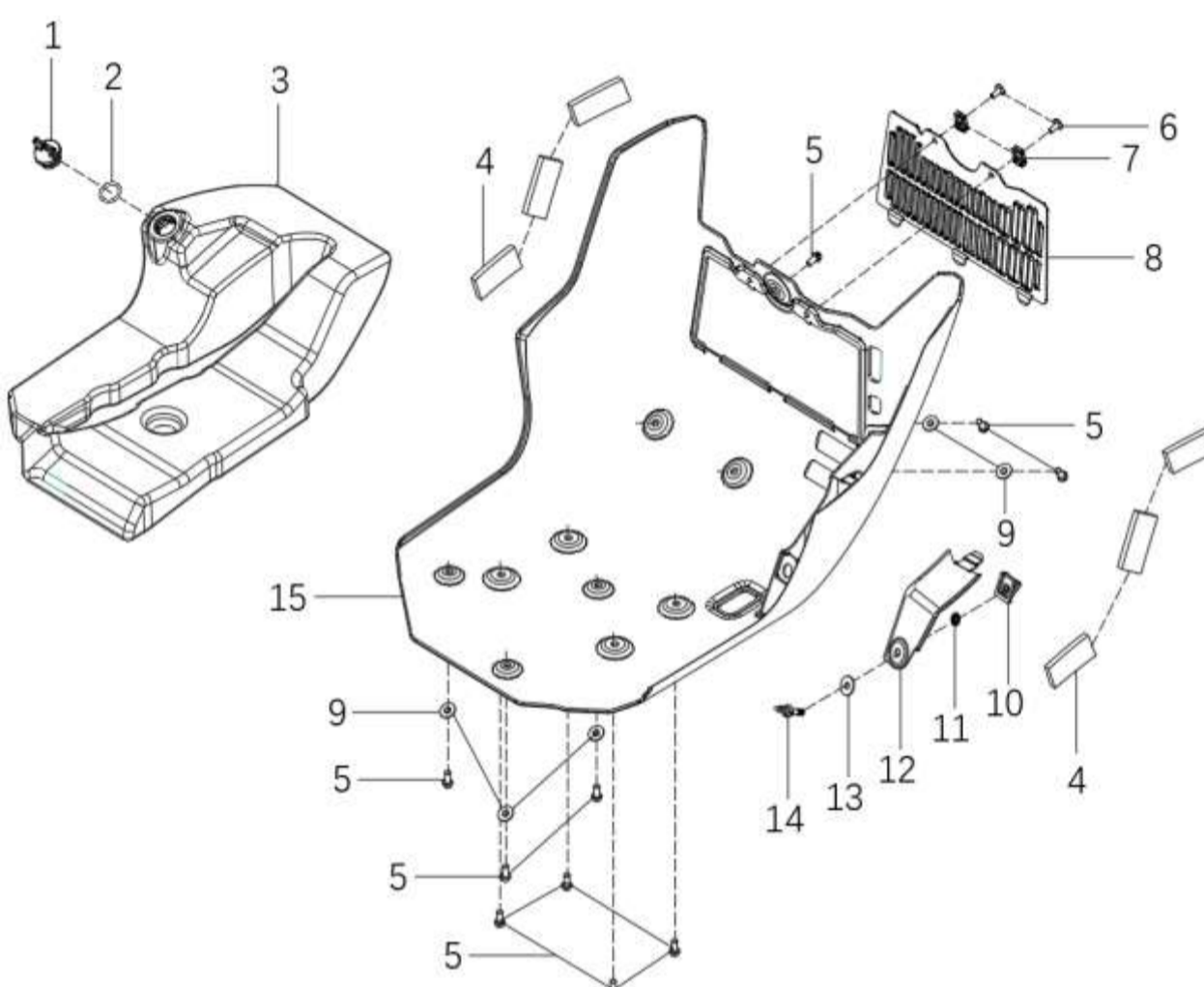
PHOTO	NO.	Part CODE	Chinese/Chinese/English name and specification	UNIT
	1	300501-T501-00000	应急储水壶盖子 Cover, Emergency Water Storage	PIECE
	2	5104-019030-000	O型圈 O-Ring	PIECE
	3	300500-T501-00000	应急储水壶 Emergency Water Storage	PIECE
	4	900005-T501-00000	耐磨贴 Wear-resisting Stick	PIECE
	5	5021-06013-BS01	内六花六角法兰面螺栓M6*13(盘18) Bolt, Hex. Flange M6*13 (Panhead 18)	PIECE
	6	5021-05012-BS00	内六花六角法兰面螺栓M5*12 Bolt, Hex. Flange M5*12	PIECE
	7	5009-05070-DK00	螺纹夹板M5 Clip, Screw Thread M5	PIECE
	8	390097-T501-00000	油冷格栅 Oil Cooling Grille	PIECE
	9	5018-06015-BS00	平垫 $\phi 6 * \phi 18 * 1.5$ Washer, Flat $\phi 6 * \phi 18 * 1.5$	PIECE
	10	5009-06093-BS00	搭扣 Buckle	PIECE
	11	5020-05405-BS00	挡圈 $\phi 5.4 * \phi 12.5 * 0.5$ Collar $\phi 5.4 * \phi 12.5 * 0.5$	PIECE
	12	390078-T501-00000	工具箱盖 Cover, Tool Box	PIECE
	13	5018-06520-BS00	平垫 $\phi 6.5 * \phi 20 * 2$ Washer, Flat $\phi 6.5 * \phi 20 * 2$	PIECE
	14	5007-06016-HX00	1/4转快锁式螺栓 1/4 Quick-lock Bolt	PIECE
	15	390029-T501-00000	发动机下护板 Protecting Plate, Engine	PIECE
	16			
	17			
	18			
	19			
	20			

F-8 Front tank - left-1

PHOTO	NO.	Part CODE	Chinese/Chinese/English name and specification	UNIT
	1	310006-T501-00001	前油箱盖 Fuel Tank Cover, Front	PIECE
	2	420061-T501-00000	油箱盖密封圈 Cover Seal Ring, Fuel Tank	PIECE
	3	5003-08020-BS00	内六花圆柱头螺钉M8*20 Screw, Inner Hex. Column Head M8*20	PIECE
	4	5021-05012-BS00	内六花六角法兰面螺栓M5*12 Bolt, Hex. Flange M5x12	PIECE
	5	910013-T501-00000	前油箱安装衬套 Front Fuel Tank Mounting Bushing	PIECE
	6	360045-T501-00000	油箱前护板支架 Fuel Tank Front Guard Bracket	PIECE
	7	5009-06093-BS00	搭扣M6*9.3, 宽25长25 Buckle M6*9.3, Wide: 25, Length: 25	PIECE
	8	420008-T501-00001	工字胶圈 $\phi 29 * \phi 19.5 * 25$ Ring, Rubber I-Shaped $\phi 29 * \phi 19.5 * 25$	PIECE
	9	421800-T501-00001	前油箱-左 Front Fuel Tank - Left	PIECE
	10	421800-T501-00000	油箱通气管总成 Fuel Tank Vent Pipe Assembly	PIECE
	11	310009-T501-00000	通气管固定底座 Fixed Base, Vent Pipe	PIECE
	12	360036-T501-00000	燃油滤清器支架 Fuel Filter Bracket	PIECE
	13	5005-05012-BS00	十字盘头螺钉M5*12 Screw, Cross-Shaped, Cup Head M5*12	PIECE
	14	5003-08030-BS01	内六花圆柱头螺钉M8*30 Screw, Inner Hex. Column Head M8*30	PIECE
	15	420008-T501-00002	工字胶圈 $\phi 29 * \phi 19.5 * 29.5$ Ring, Rubber I-Shaped $\phi 29 * \phi 19.5 * 29.5$	PIECE
	16	5008-16030-SC00	六角螺母M16*1, 厚3 Bolt, Hex M16*1, THK: 3	PIECE
	17	360046-T501-00000	前油箱支架 Front Fuel Tank Bracket	PIECE
	18	5027-08020-BS00	橡胶螺栓M8*20 Elastic Rubber, Bolts M8*20	PIECE
	19	360047-T501-00003	前油箱安装螺母(内M8, 外M16*1*11, 长度35.5mm) Front fuel tank mounting nut (Inner:M8, Outer: M16*1*11, Length:35.5mm)	PIECE
	20	5021-08010-BS00	内六花六角法兰面螺栓M8*10(盘16) Bolt, Hex. Flange M8x10Panhead 16)	PIECE

F-8 Front tank - left-2

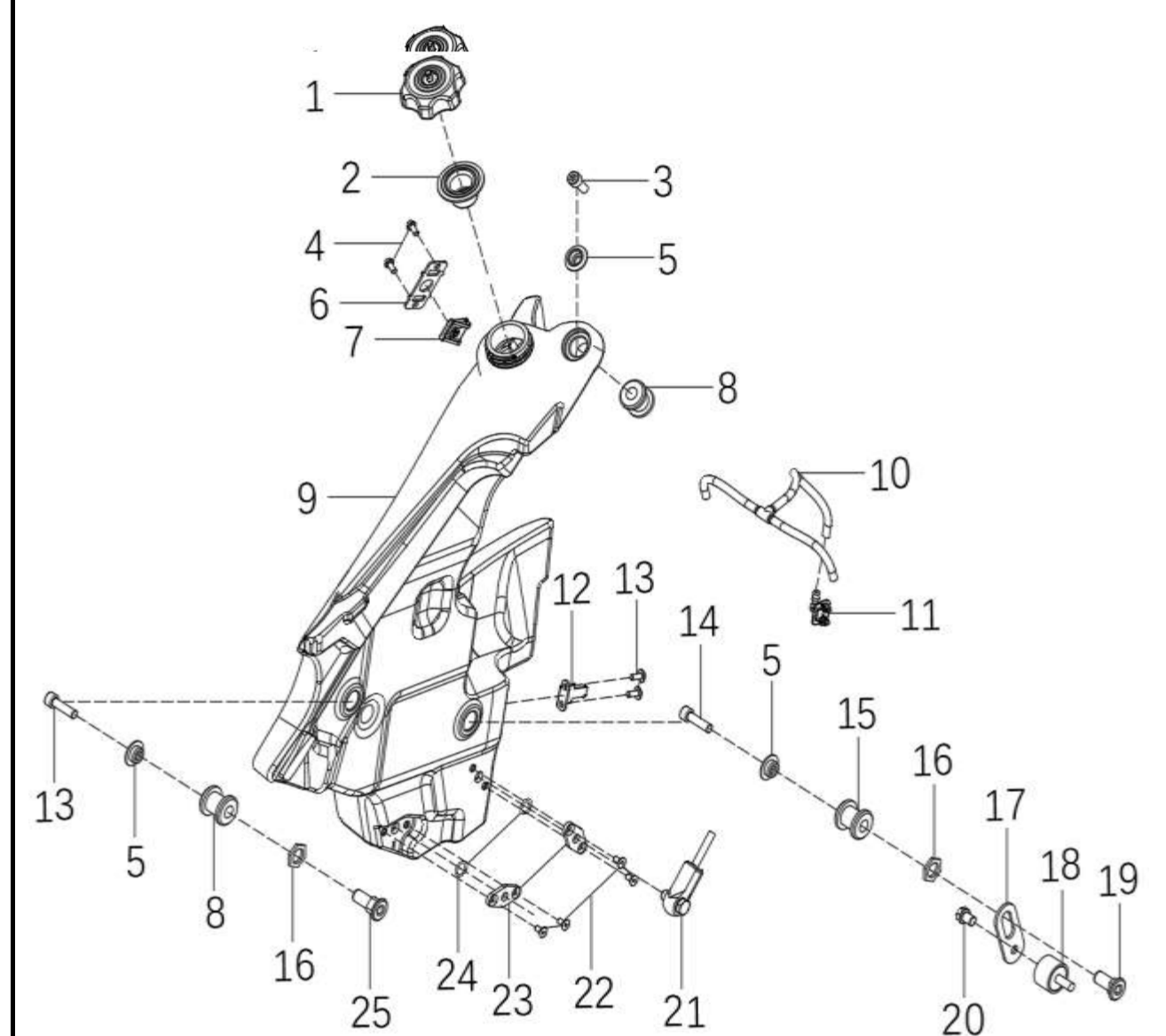
PHOTO	NO.	Part CODE	Chinese/Chinese/English name and specification	UNIT
	21	310402-T500-00000	油位传感器 Oil Level Sensor	PIECE
	22	5014-05010-BS01	内六角沉头螺钉M5*10 Screw, Inner Hex, Countersunk Head M5*10	PIECE
	23	310011-T501-00000	油管接头安装板 Fuel Pipe Union Mounting Plate	PIECE
	24	5104-012020-000	O型圈 $\phi 12 * \phi 2$ O-Ring $\phi 12 * \phi 2$	PIECE
	25	360047-T501-00002	前油箱安装螺母 (内M8, 外M16*1*6, 长度30.5mm) Front Fuel Tank Mounting Nut (Inner:M8, Outer:M16*1*6, Length30.5mm)	PIECE
	26			
	27			
	28			
	29			
	30			
	31			
	32			
	33			
	34			
	35			
	36			
	37			
	38			
	39			
	40			

F-9 Front tank - right

PHOTO	NO.	Part CODE	Chinese/Chinese/English name and specification	UNIT	
	1	5003-08020-BS00	内六花圆柱头螺钉M8*20	Screw, Inner Hex. Column Head M8*20	PIECE
	2	910013-T501-00000	前油箱安装衬套	Front Fuel Tank Mounting Bushing	PIECE
	3	420008-T501-00001	工字胶圈 $\phi 29 * \phi 19.5 * 25$	Ring, Rubber I-Shaped $\phi 29 * \phi 19.5 * 25$	PIECE
	4	5021-05012-BS00	内六花六角法兰面螺栓M5*12	Bolt, Hex. Flange M5x12	PIECE
	5	5009-06093-BS00	搭扣M6*9.3, 宽25长25	Buckle M6*9.3, Wide:25 Length: 25	PIECE
	6	360045-T501-00000	油箱前护板支架	Fuel Tank Front Guard Bracket	PIECE
	7	311300-T501-00000	前油箱-右	Front Fuel Tank-Rght	PIECE
	8	5003-08030-BS00	内六角圆柱头螺钉M8*30	Screw, Inner Hex. Column Head M8*30	PIECE
	9	5008-16030-SC00	六角螺母M16*1, 厚3	Bolt, Hex M16*1, THK:3	PIECE
	10	360047-T501-00002	前油箱安装螺母(内M8, 外M16*1*6, 长度30.5mm)	Front fuel tank mounting nut (Inner: M8, Outer: M16*1*6, L: 30.5mm)	PIECE
	11	360047-T501-00003	前油箱安装螺母(内M8, 外M16*1*11, 长度35.5mm)	Front fuel tank mounting nut (Inner: M8, Outer: M16*1*11, L: 35.5mm)	PIECE
	12	5027-08020-BS00	橡胶螺栓M8*20	Rubber Bolt M8*20	PIECE
	13	360046-T501-00000	前油箱支架	Front Fuel Tank Bracket	PIECE
	14	5021-08010-BS00	内六花六角法兰面螺栓M8x10(盘16)	Bolt, Hex. Flange M8x10 (Panhead 16)	PIECE
	15	420008-T501-00002	工字胶圈 $\phi 29 * \phi 19.5 * 29.5$	Ring, Rubber I-Shaped $\phi 29 * \phi 19.5 * 29.5$	PIECE
	16	5014-05010-BS01	内六角沉头螺钉M5*10	Screw, Inner Hex, Countersunk Head M5*10	PIECE
	17	310011-T501-00000	油管接头安装板	Mounting Plate, Fuel Pipe Union	PIECE
	18	5104-012020-000	O型圈 $\phi 12 * \phi 2$	O-Ring $\phi 12 * \phi 2$	PIECE
	19	900005-T501-00000	耐磨贴	Wear-Resistant Sticker	PIECE
	20	420061-T501-00000	油箱盖密封圈	Cover Seal, Fuel Tank	PIECE

F-9 Front tank - right-1

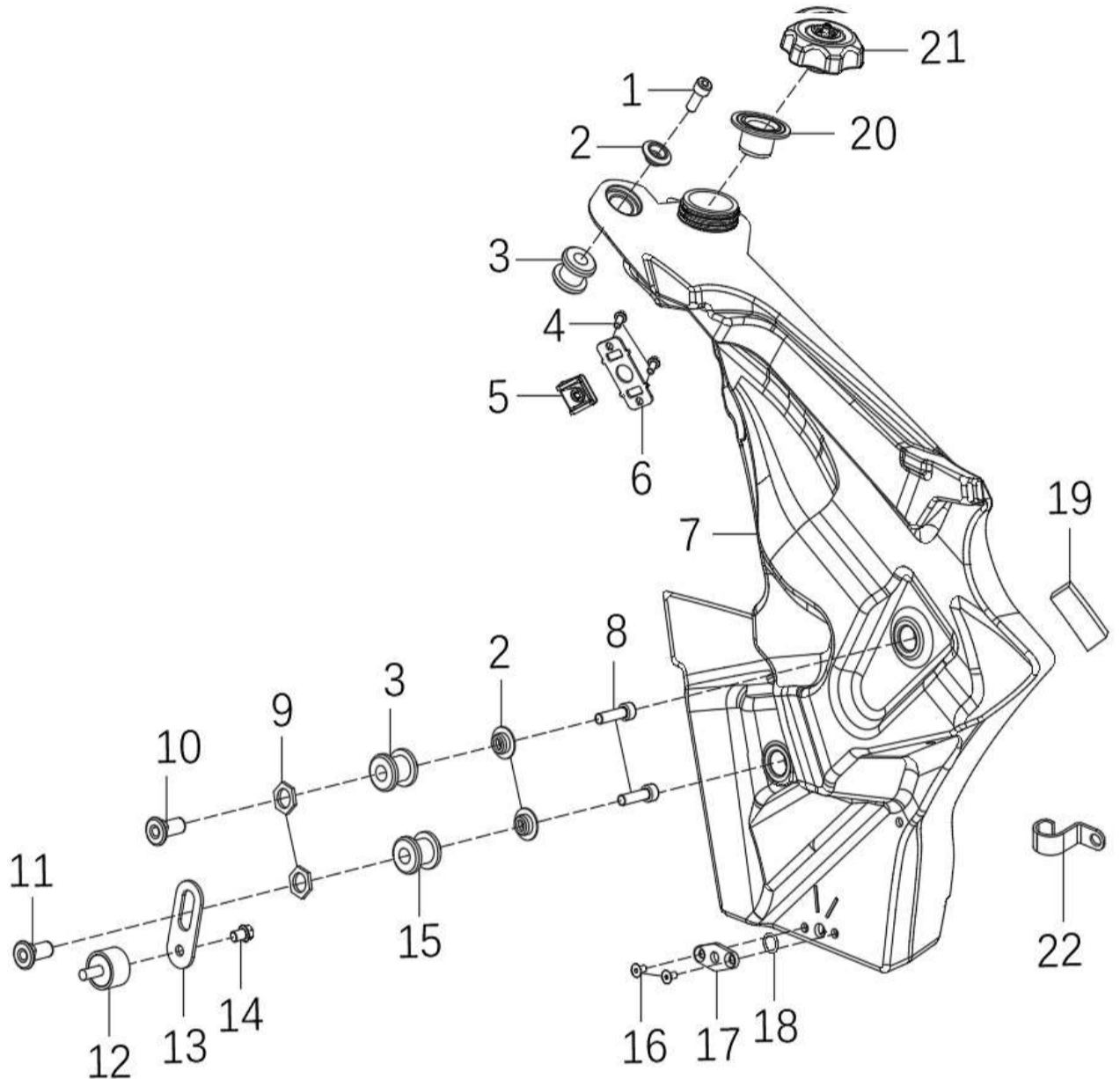
PHOTO	NO.	Part CODE	Chinese/Chinese/English name and specification	UNIT
	21	310006-T501-00001	前油箱盖 Front Fuel Tank Cover	PIECE
	22	400006-R100-000	线钩 wire hook	
	23			
	24		3 complete sticker decal kits for Rally standard complete motorcycle	3
	25			
	26			
	27			
	28			
	29			
	30			
	31			
	32			
	33			
	34			
	35			
	36			
	37			
	38			
	39			
	40			

F-10 Rear oil tank-1

PHOTO	NO.	Part CODE	Chinese/Chinese/English name and specification	UNIT	
	1	5007-08011-BS01	后油箱安装螺栓M8*11, 台阶25	Rear Fuel Tank Mounting Bolt M8*11, Stepping 25	PIECE
	2	420049-T501-00000	后油箱支撑胶	Rear Fuel Tank Support Rubber	PIECE
	3	310007-T501-00001	后油箱盖	Cover, Rear Fuel Tank	PIECE
	4	420061-T501-00000	油箱盖密封圈	Fuel Tank Cover Seal	PIECE
	5	311700-T501-00000	单向透气阀	One-way Vent Valve	PIECE
	6	310008-T501-00000	后油箱通气管接头	Rear Fuel Tank Vent Pipe Connector	PIECE
	7	5104-005020-000	O型圈 $\phi 5 * \phi 2$	O-Ring $\phi 5 * \phi 2$	PIECE
	8	420048-T501-00000	侧支架挂钩	Side Stand Hook	PIECE
	9	360048-T501-00000	侧支架挂钩支架	Side Stand Hook Bracket	PIECE
	10	5021-05012-BS00	内六角六角法兰面螺栓M5*12	Bolt, Hex. Flange	PIECE
	11	390082-T501-00000	后油箱保护罩	Rear Fuel Tank Protection Cover	PIECE
	12	5018-06015-BS00	平垫 $\phi 6 * \phi 18 * 1.5$	Washer, Flat $\phi 6 * \phi 18 * 1.5$	PIECE
	13	5004-06012-BS04	内六角台阶螺钉M6*12, 台阶8.5*3.5	Stepping Screw, Inner Hex. M6*12, Stepping 8.5*3.5	PIECE
	14	390083-T501-00000	后轮挡水皮	Rear wheel water barrier leather	PIECE
	15	5014-06012-BS01	内六角沉头螺钉M6*12	Screw, Inner Hex, Countersunk Head M6*12	PIECE
	16	5021-06013-BS00	内六角六角法兰面螺栓M6*13(盘14)	Bolt, Hex. Flange M6x13 (Panhead 14)	PIECE
	17	360041-T501-00000	消声器安装支架	Muffler mounting bracket	PIECE
	18	910011-R100-000	衬管 $\phi 8 * \phi 12.5 * 29$	Sleeve $\phi 8 * \phi 12.5 * 29$	PIECE
	19	371001-R201-000	后脚蹬安装工字胶 $\phi 12 * \phi 23.5 * 30$	I-Shaped Installation Rubber, Rear Foot Pedal $\phi 12 * \phi 23.5 * 30$	PIECE
	20	5104-012020-000	O型圈 $\phi 12 * \phi 2$	O-Ring $\phi 12 * \phi 2$	PIECE

F-10 Rear oil tank-2

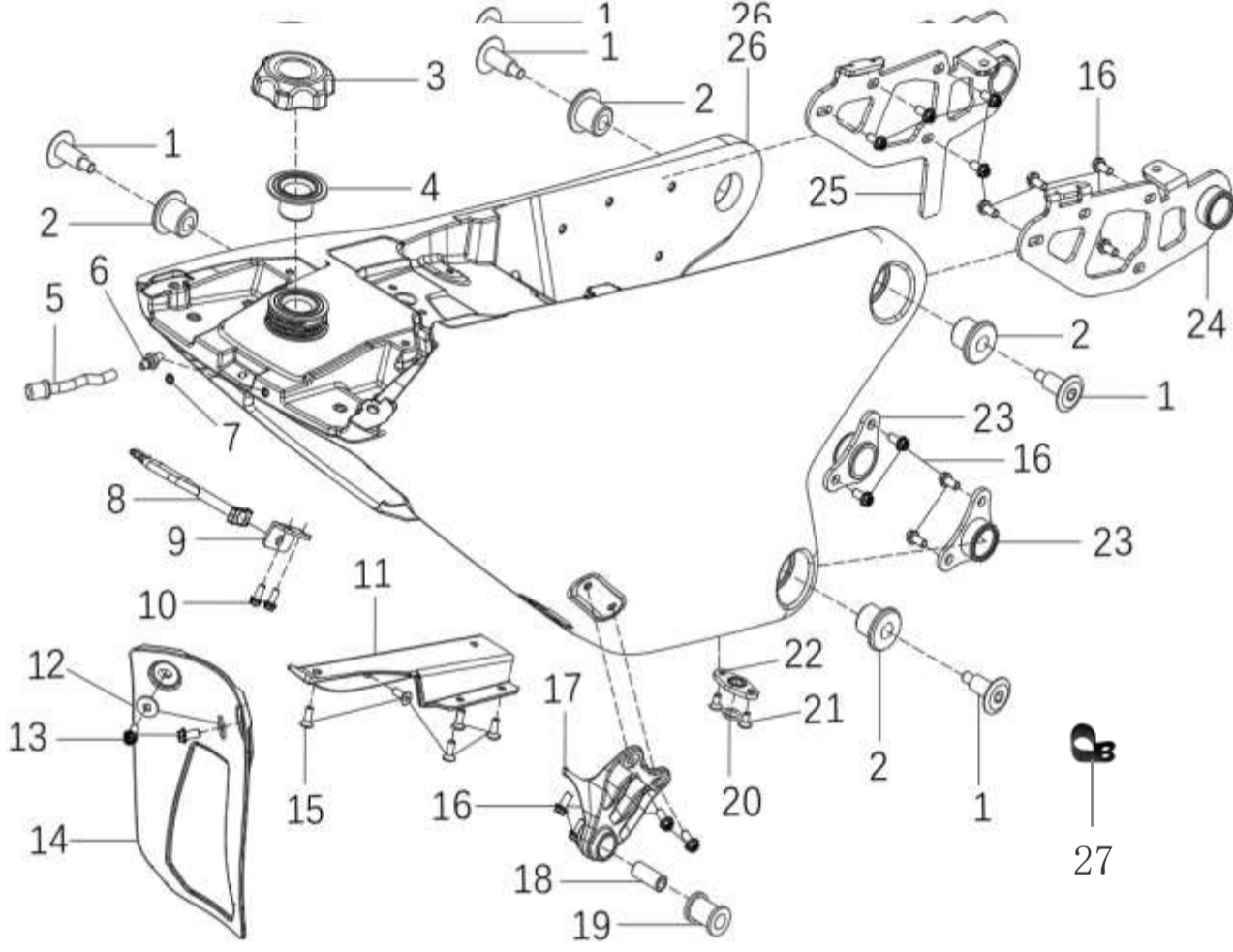
PHOTO	NO.	Part CODE	Chinese/Chinese/English name and specification	UNIT
	21	5014-05010-BS01	内六角沉头螺钉M5*10 Screw, Inner Hex, Countersunk Head M5*10	PIECE
	22	310011-T501-00000	油管接头安装板 Mounting Plate, Fuel Pipe Union	PIECE
	23	360049-T501-00000	后油箱下支架 Lower Bracket, Rear Fuel Tank	PIECE
	24	360051-T501-00000	后油箱加强支架-右 Reinforcement Support Right, Rear Fuel Tank	PIECE
	25	360050-T501-00000	后油箱加强支架-左 Reinforcement Support Left, Rear Fuel Tank	PIECE
	26	311400-T501-00000	后油箱 Rear Fuel Tank	PIECE
	27	400006-T501-00001	线钩 $\phi 12*12$ wire hook	
	28			
	29			
	30			
	31			
	32			
	33			
	34			
	35			
	36			
	37			
	38			
	39			
	40			

F-11 Electrical components-1

PHOTO	NO.	Part CODE	Chinese/Chinese/English name and specification	UNIT	
	1	5014-06020-BS01	内六角沉头螺钉M6*20	Screw, Inner Hex, Countersunk Head	PIECE
	2	331806-T501-00000	座垫锁座	Cushion Lock Set	PIECE
	3	310200-T501-00000	ECU	ECU	PIECE
	4	5005-05012-BS00	十字盘头螺钉M5*12	Screw, Cross-Shaped, Cup Head M5*12	PIECE
	5	330100-R100-00001	启动继电器	Starting Relay	PIECE
	6	420900-T501-00000	电瓶绑带	Battery straps	PIECE
	7	331400-T501-00001	电瓶	Battery	PIECE
	8	5006-04013-HX00	自攻钉M4.2*13	Tapping Screw M4.2X13	PIECE
	9	331600-R110-00000	继电器	Relay	PIECE
	10	332600-T501-00000	点火线圈	Ignition Coil	PIECE
	11	5009-05070-DK00	螺纹夹板M5	Clip, Screw Thread M5	PIECE
	12	332000-R201-000	侧倾传感器	Sensor, Toppling	PIECE
	13	5018-05008-SC00	平垫 φ5	Washer, Flat φ5	PIECE
	14	5004-05016-BS02	内六角盘头螺钉M5*16	Screw, Inner Hex. Flat Head M5*16	PIECE
	15	330200-T501-00001	调压整流器	Rectifier & Regulator Assy	PIECE
	16	5009-06080-DK00	螺纹夹板M6	Clip, Screw Thread M6	PIECE
	17	5005-06025-BS00	十字盘头螺钉M6*25	Screw, Cross-Shaped, Cup Head M6*25	PIECE
	18	5021-06020-BS00	内六角六角法兰面螺栓M6*20(盘11)	Bolt, Hex. Flange M6x20 (Panhead 11)	PIECE
	19	420008-R100-000	工字胶圈 φ9*φ19.5*9	Ring, Rubber I-Shaped φ9*φ19.5*9	PIECE
	20	360900-T501-00000	电器安装支架总成	Electrical components Mounting Bracket Assembly	PIECE

F-11 Electrical components-1

PHOTO	NO.	Part CODE	Chinese/Chinese/English name and specification	UNIT	
	21	330600-T501-00001	喇叭 Horn	PIECE	
	22	5021-06012-BS00	内六花六角法兰面螺栓M6*12(盘11) Bolt, Hex. Flange M6x12 (Panhead 11)	PIECE	
	23	331700-T501-00001	主电缆 Wire Harness Assy	PIECE	
	24				
	25				
	26				
	27				
	28				
	29				
	30				
	31				
	32				
	33				
	34				
	35				
	36				
	37				
	38				
	39				
	40				

F-12 Electrical components-2

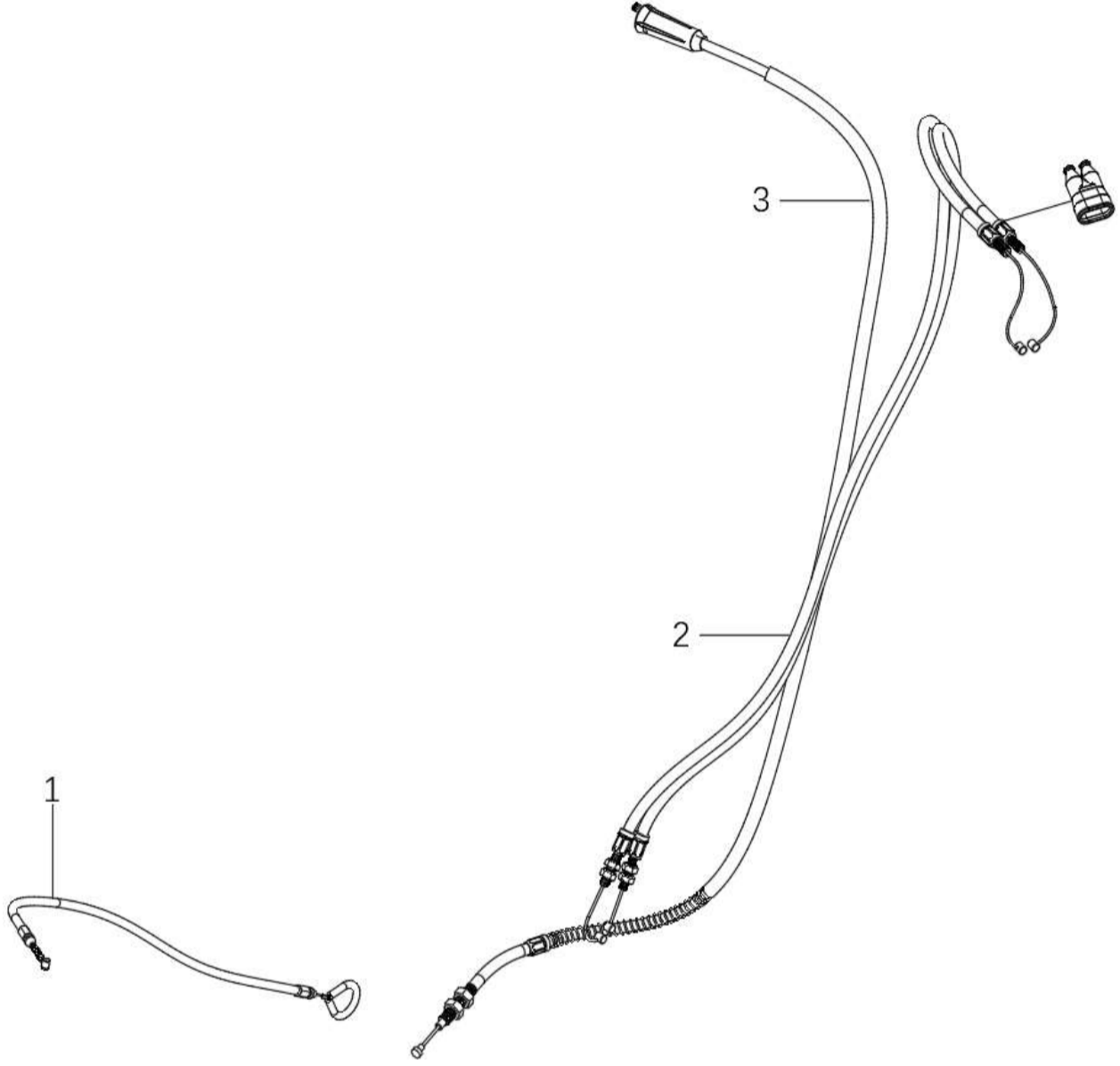
PHOTO	NO.	Part CODE	Chinese/Chinese/English name and specification	UNIT
	1	380600-T501-00000	座垫锁拉索 Seat Lock Cable	PIECE
	2	311900-T501-00000	油门拉索总成 Throttle Cable Assembly	PIECE
	3	380500-T501-00001	离合拉索 Clutch Cable	PIECE
	4			
	5			
	6			
	7			
	8			
	9			
	10			
	11			
	12			
	13			
	14			
	15			
	16			
	17			
	18			
	19			
	20			

F-13 Front fender

PHOTO	NO.	Part CODE	Chinese/Chinese/English name and specification	UNIT
	1	5013-06006-BS00	翻边衬套 Φ6*Φ9*6 Bushing, Flange Φ6xΦ9x6	PIECE
	2	390015-T501-00000	前挡泥板 Front Fender	PIECE
	3	5018-06015-BS00	平垫 φ 6* φ 18*1.5 Washer, Flat φ 6* φ 18*1.5	PIECE
	4	5021-06020-BS00	内六花六角法兰面螺栓M6*20(盘11) Bolt, Hex. Flange M6x20 (Panhead 11)	PIECE
	5			
	6			
	7			
	8			
	9			
	10			
	11			
	12			
	13			
	14			
	15			
	16			
	17			
	18			
	19			
	20			

F-14 Throttle Body Assy

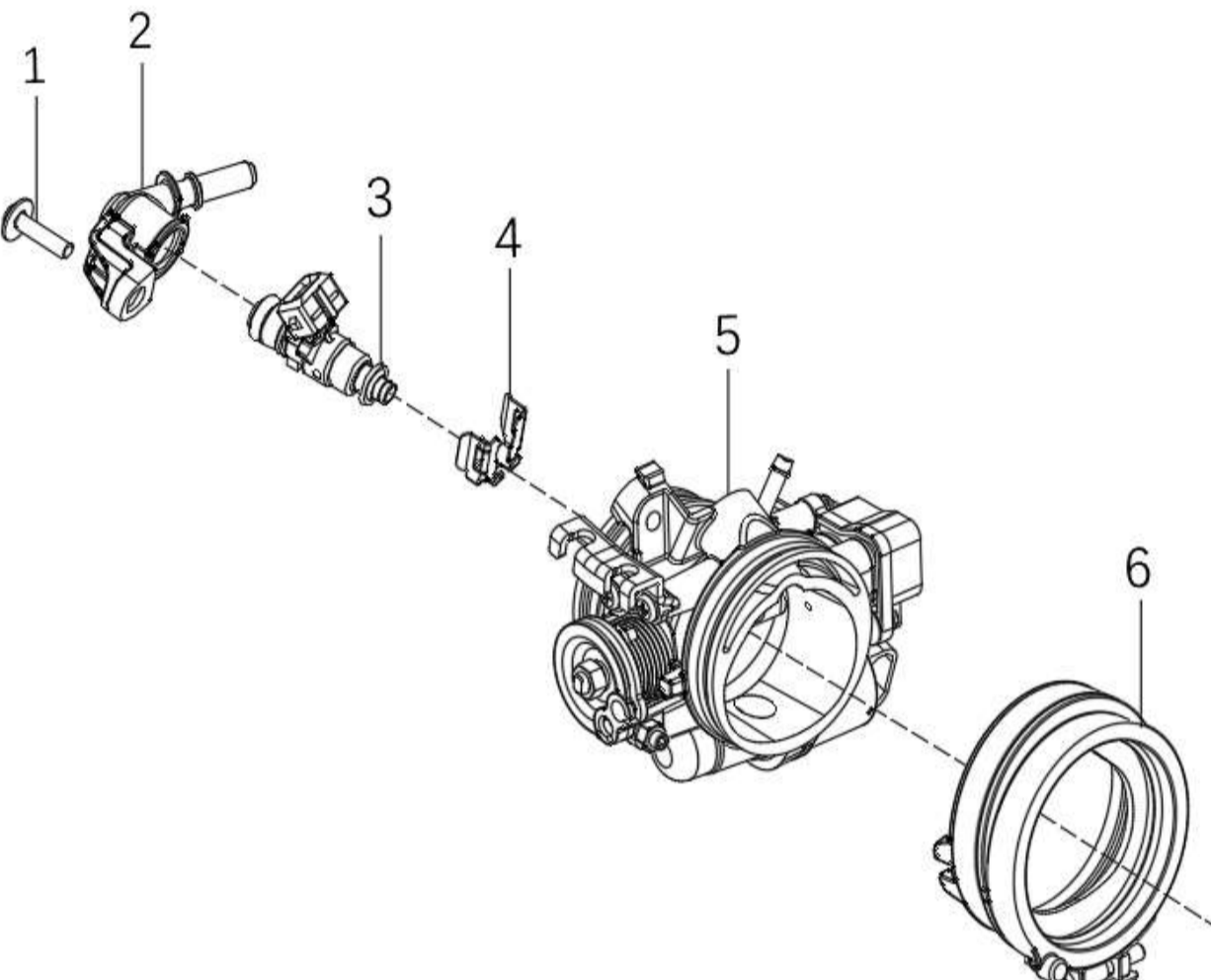
PHOTO	NO.	Part CODE	Chinese/English name and specification	UNIT
	1	5021-06020-BS00	内六花六角法兰面螺栓M6*20(盘11)	Bolt, Hex. Flange M6x20 (Panhead 11)
	2	310012-T501-00000	喷油器帽	Fuel Injector Cap
	3	310101-T501-00000	喷油器	Fuel Injector
	4	310005-P200-00000	喷油器卡夹	Fuel Injector Clamp
	5	310100-T501-00000	节气门总成	Throttle Body Assy
	6	320500-T501-00000	进气管总成	Intake Pipe Assy
	7			
	8			
	9			
	10			
	11			
	12			
	13			
	14			
	15			
	16			
	17			
	18			
	19			
	20			

F-15 Fuel evaporation system

PHOTO	NO.	Part CODE	Chinese/Chinese/English name and specification		UNIT
	1	350100-R100-000	快速接头	Quick Coupling	PIECE
	2	5011-01570-BS00	单耳无极卡箍	Clip	PIECE
	3	420054-T501-00000	燃油管6	Fuel Pipe 6	PIECE
	4	310500-R100-000	燃油滤清器	Fuel Filter	PIECE
	5	420046-P200-00000	燃油滤清器胶套	Fuel Filter Sleeve	PIECE
	6	420053-T501-00000	燃油管5	Fuel Pipe 5	PIECE
	7	310400-T501-00000	燃油泵	Fuel Pump	PIECE
	8	5005-05020-SC00	内六角盘头螺钉M5*20	Screw, Inner Hex. Flat Head M5*20	PIECE
	9				
	10				
	11				
	12				
	13				
	14				
	15				
	16				
	17				
	18				
	19				
	20				

F-15 Fuel evaporation system-1

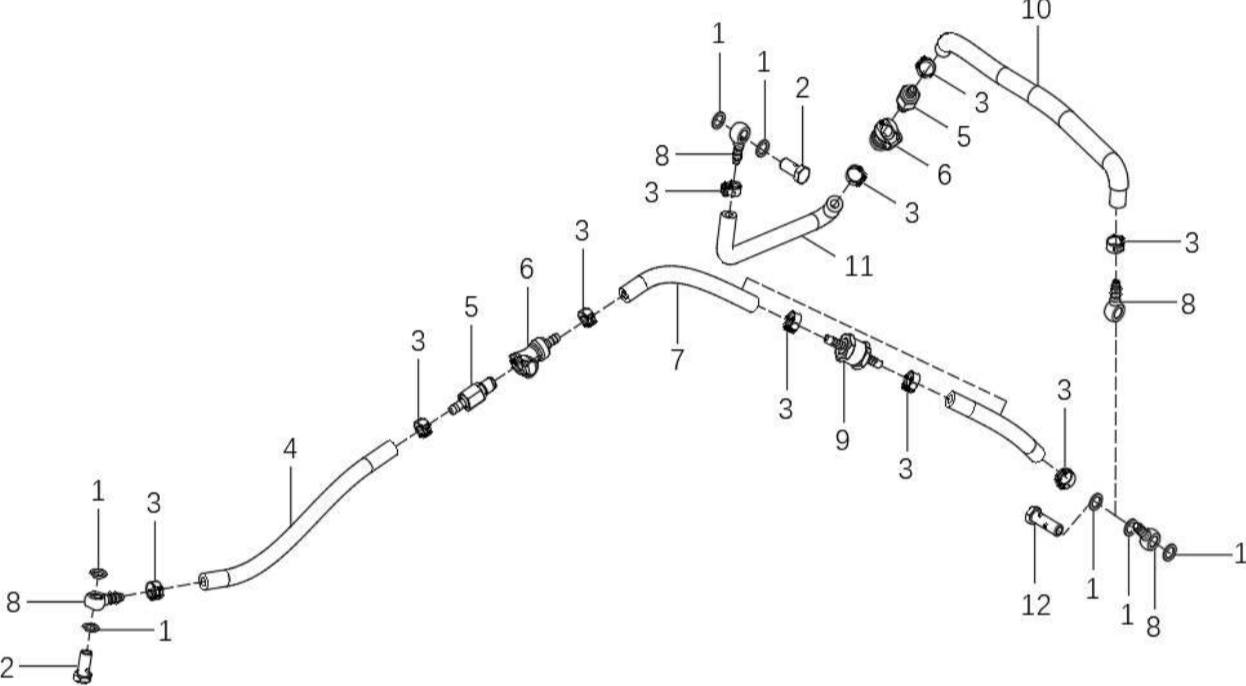
PHOTO	NO.	Part CODE	Chinese/Chinese/English name and specification	UNIT	
	1	350002-R100-000	铜垫圈 $\phi 10*\phi 15*1.5$	Copper Washer $\phi 10*\phi 15*1.5$	PIECE
	2	350001-T501-00004	过油螺栓M10*1.0*20	Oil Bolt M10*1.0*20	PIECE
	3	5011-01570-BS00	单耳无极卡箍	Clip	PIECE
	4	420001-T501-00000	燃油管1	Fuel Pipe 1	PIECE
	5	311000-T501-00000	快速插头公头	Quick Plug Male Head	PIECE
	6	311100-T501-00000	快速插头母头	Quick Plug Female Head	PIECE
	7	420002-T501-00000	燃油管2	Fuel Pipe 2	PIECE
	8	310010-T501-00000	球形油管接头	Spherical Tubing Joint	PIECE
	9	311800-T501-00000	单向阀	One-way Valve	PIECE
	10	420051-T501-00000	燃油管3	Fuel Pipe 3	PIECE
	11	420052-T501-00000	燃油管4	Fuel Pipe 4	PIECE
	12	350001-T501-00002	过油螺栓M10*1*30	Oil Bolt M10*1*30	PIECE
	13				
	14				
	15				
	16				
	17				
	18				
	19				
	20				

F-16 Headlight bracket

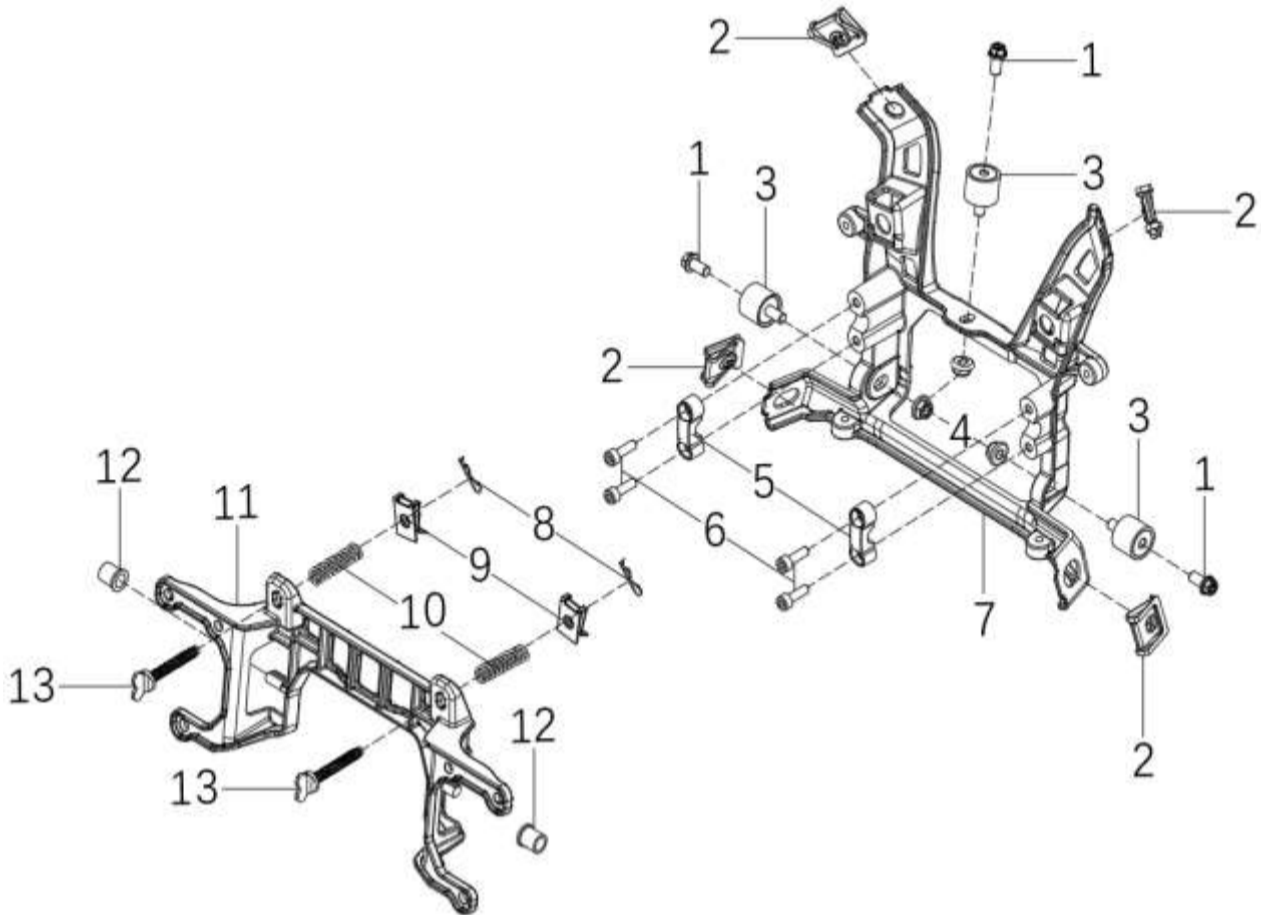
PHOTO	NO.	Part CODE	Chinese/Chinese/English name and specification	UNIT	
	1	5021-06013-BS00	内六角六角法兰面螺栓M6*13 (盘14)	Bolt, Hex. Flange M6x13 (Panhead 14)	PIECE
	2	5009-06093-BS00	搭扣M6*9.3, 宽25长25	Buckle M6*9.3, Wide: 25, Length: 25	PIECE
	3	5027-06012-BS00	橡胶螺栓M6*12	Rubber Bolt M6*12	PIECE
	4	5008-06070-SC00	六角法兰面自锁螺母M6	Tapping Nut, Hex. Flange M6	PIECE
	5	360022-R201-000	大灯支架压板	Press-plate, Headlight Bracket	PIECE
	6	5003-05012-BS00	内六角圆柱头螺钉M5*12	Screw, Inner Hex. Column Head M5*12	PIECE
	7	360044-T501-00000	大灯安装支架	Headlight Mounting Bracket	PIECE
	8	5015-03020-SC00	开口销 $\phi 0.9$	Pin, Split $\phi 0.9$	PIECE
	9	5009-06080-DK00	螺纹夹板M6*1.0*8*16	Clip, Screw Thread M6*1.0*8*16	PIECE
	10	5012-01036-SC00	大灯调节弹簧 $\phi 1.4 * \phi 8.6 * 36$	Adjusting Spring, Headlight $\phi 1.4 * \phi 8.6 * 36$	PIECE
	11	360014-T501-00000	大灯支架	Bracket, Headlight	PIECE
	12	420036-R201-000	大灯支架胶套 $\phi 8 * \phi 11 / \phi 13 * 12.8$	Rubber, Headlight Bracket $\phi 8 * \phi 11 / \phi 13 * 12.8$	PIECE
	13	5007-06041-BS01	大灯调节螺栓M6*41	Headlight Adjusting Screw M6*41	PIECE
	14				
	15				
	16				
	17				
	18				
	19				
	20				

F-17 Engine

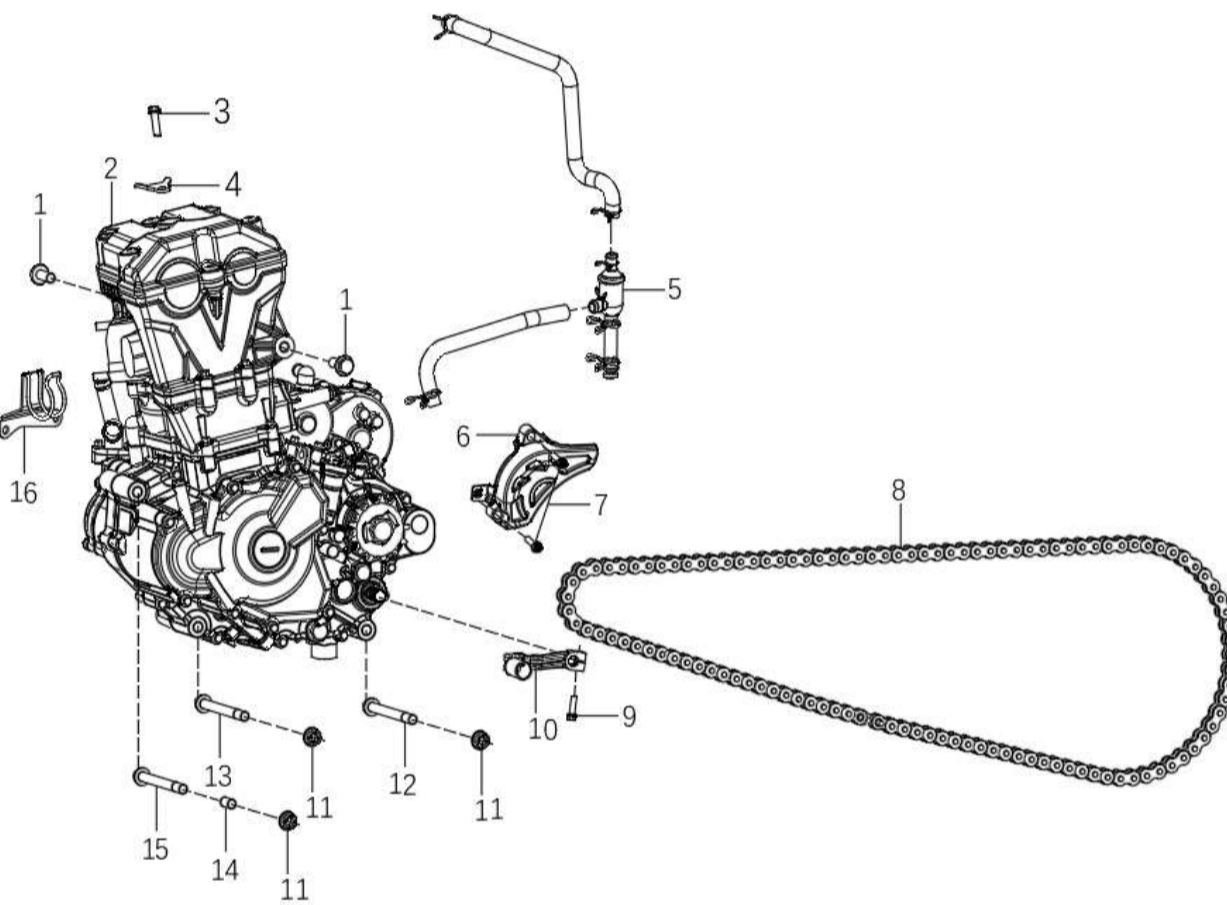
PHOTO	NO.	Part CODE	Chinese/Chinese/English name and specification		UNIT
	1	5001-10030-BS00	六角法兰面螺栓M10*30*1.25	Bolt, Hex. Flange M10*30*1.25	PIECE
	2	AEDT01-B09	发动机总成 (NC450S, 油冷管接口M10*1.25)	Engine Assy. (NC450S, Oil cooling pipe connection M10*1.25)	PIECE
	3	5021-06012-BS00	内六花六角法兰面螺栓M6*12	Bolt, Hex. Flange M6*12	PIECE
	4	360088-T501-00000	高压包压板	Pressing Pate, Coil to Spark Plug	PIECE
	5	421700-T501-00000	废气管总成	Exhaust Pipe Assembly	PIECE
	6	390023-T501-00000	发动机小链轮盖	Cover, Engine Sprocket	PIECE
	7	5021-06030-BS00	内六花六角法兰面螺栓M6*30 (盘11)	Bolt, Hex. Flange M6x30 (Panhead 11)	PIECE
	8	352300-T501-00000	链条	Chain	PIECE
	9	5021-06020-BS00	内六花六角法兰面螺栓M6*20 (盘11)	Bolt, Hex. Flange M6x20 (Panhead 11)	PIECE
	10	370200-T501-00000	变档踏板总成	Pedal, Gear Shift Assy	PIECE
	11	5008-10115-SC00	六角法兰面自锁螺母M10*1.25	Tapping Nut, Hex. Flange M10*1.25	PIECE
	12	5001-10130-BS00	六角法兰面螺栓M10*1.25*130	Bolt, Hex. Flange M10*1.25*130	PIECE
	13	5001-10145-BS00	六角法兰面螺栓M10*1.25*145	Bolt, Hex. Flange M10x1.25*145	PIECE
	14	910004-P200-00002	衬套 $\phi 10 * \phi 24 * 5$	Bushing $\phi 10 * \phi 24 * 5$	PIECE
	15	5001-10115-BS00	六角法兰面螺栓M10*1.25*115	Bolt, Hex. Flange M10*1.25*115	PIECE
	16	400006-R100-000	线钩	Hook	PIECE
	17				
	18				
	19				
	20				

F-18 Steering handle

PHOTO	NO.	Part CODE	Chinese/Chinese/English name and specification	UNIT	
	1	5004-05010-BS01	内六角台阶螺钉M5*10	Stepping Screw, Inner Hex. M5X10	PIECE
	2	390007-T501-00000	手挡风-左	Hand Shield(Left)	PIECE
	3	370009-T501-00000	手挡风支架	Bracket, Hand Shield	PIECE
	4	5014-08045-BS00	内六花沉头螺钉M8*45	Screw, Inner Hex, Countersunk Head M8*45	PIECE
	5	910018-T501-00001	手挡风衬套	Bushing, Hand Shield	PIECE
	6	910018-T501-00000	手挡风衬套	Bushing, Hand Shield	PIECE
	7	380100-T501-00000	手把胶-左	Grip(Left), Handle Bar	PIECE
	8	/	仪表开关支架(除仪表开关支架外的零部件为速度仪表二级物料, 不能单独采购)	Meter operation switch (speed meter secondary materials, can not be purchased separately)	PIECE
	9	330901-T501-00000	离合手柄卡座	Holder, Lever Clutch	PIECE
	10	5021-06020-BS00	内六花六角法兰面螺栓M6*20(盘11)	Bolt, Hex. Flange M6x20 (Panhead 11)	PIECE
	11	331000-T501-00000	手把开关-左	Switch(Left), Handle Bar	PIECE
	12	5004-06020-BS01	内六花盘头螺钉M6*20	Screw, Inner Hex. Flat Head M6*20	PIECE
	13	330900-T501-00000	离合手柄总成	Lever, Clutch Assy	PIECE
	14	330902-T501-00000	离合手柄	Lever, Clutch	PIECE
	15	5021-08045-BS00	内六花六角法兰面螺栓M8*45(盘13)	Bolt, Hex. Flange M8x45 (Panhead 13)	PIECE
	16	370025-T501-00000	方向把压板	Handle Bar Pressing Plate	PIECE
	17	370002-T501-00001	方向把上卡子	Clip, Handle Bar Upper	PIECE
	18	420033-T501-00002	方向把缓冲胶套	Handle Bar Rubber Cover	PIECE
	19	420033-T501-00003	方向把缓冲胶套	Handle Bar Rubber Cover	PIECE
	20	350200-T501-00000	前制动泵	Bumper Assy, Front Brake	PIECE

F-18 Steering handle-1

PHOTO	NO.	Part CODE	Chinese/Chinese/English name and specification	UNIT	
	21	350201-T501-00000	前制动手柄 Front Brake Handle	PIECE	
	22	390008-T501-00000	手挡风-右 Hand Shield(Right)	PIECE	
	23	331100-T501-00000	手把开关-右 Switch(Right), Handle Bar	PIECE	
	24	380900-T501-00000	加油器 Fueller	PIECE	
	25	380201-T501-00000	手把胶-右 Grip(Right), Handle Bar	PIECE	
	26	380300-T501-00000	方向把 Handle Bar	PIECE	
	27	370024-T501-00001	方向把下卡座缓冲块 Buffer Holder, Handle Bar Lower	PIECE	
	28	370016-T501-00001	方向把下活动卡子固定块 Movable Clips Fixed Block, Handle Bar Lower	PIECE	
	29	370026-T501-00001	方向把下活动卡子 Movable Clips, Handle Bar Lower	PIECE	
	30	5021-10035-BS00	内六花六角法兰面螺栓M10*35 Bolt, Hex. Flange M10x35	PIECE	
	31	370001-T501-00001	方向把下卡座 Clip, Handle Bar Lower	PIECE	
	32	370023-T501-00000	方向把下卡子增高块 Clip Heightening block, Handle Bar Lower	PIECE	
	33	5021-06020-BS00	内六花六角法兰面螺栓M6*20(盘11) Bolt, Hex. Flange M6x20 (Panhead 11)	PIECE	
	34	5021-06035-BS00	内六花六角法兰面螺栓M6*35(盘11) Bolt, Hex. Flange M6x35 (Panhead 11)	PIECE	
	35	350202-T501-00000	制动手柄卡座 Brake handle Holder	PIECE	
	36				
	37				
	38				
	39				
	40				

F-19 Roadbook assembly

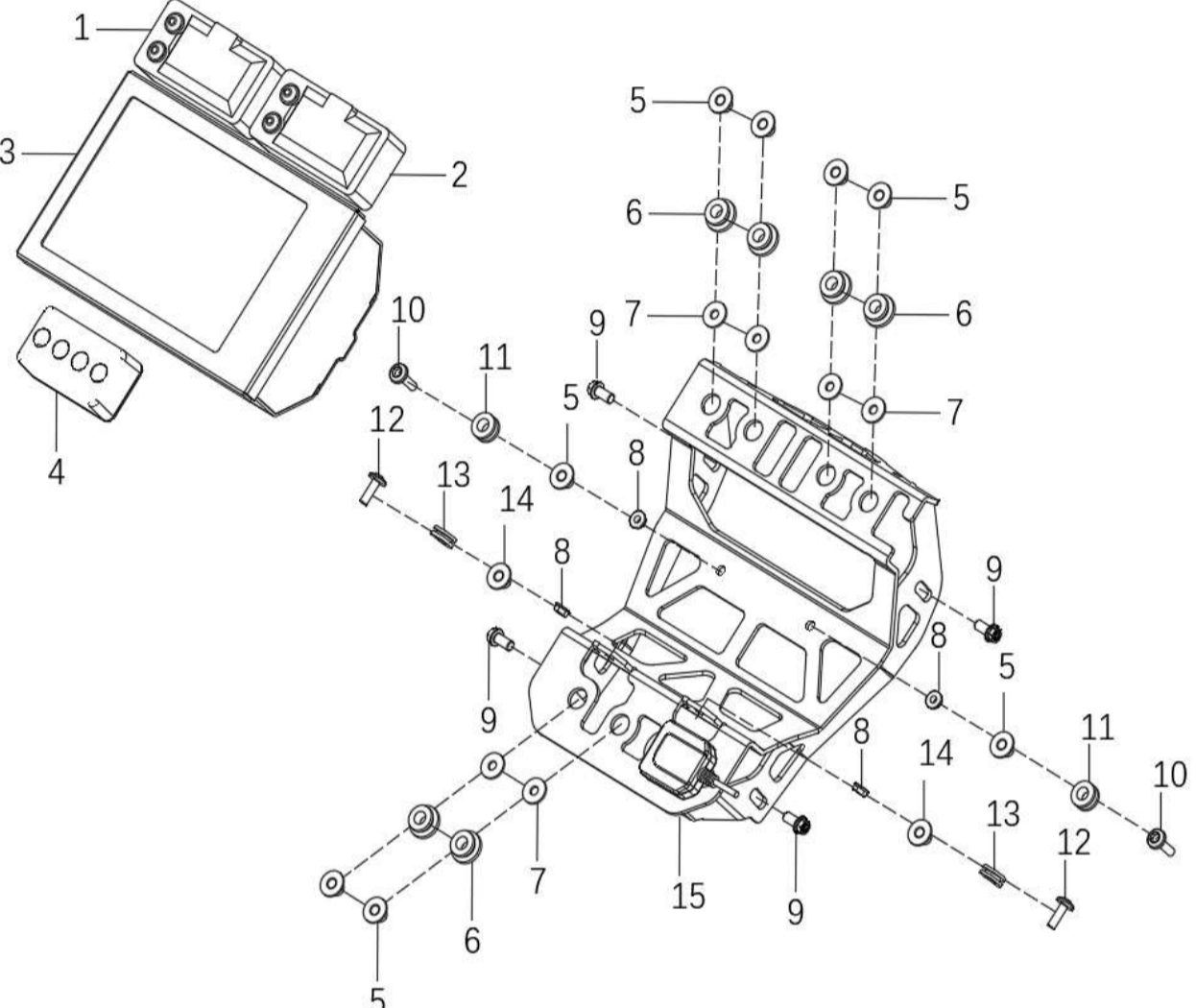
PHOTO	NO.	Part CODE	Chinese/Chinese/English name and specification	UNIT
	1	330800-T501-00001	仪表总成(速度仪表) Speedometer Assy	PIECE
	2	330800-T501-00000	仪表总成(航向仪表) Navigation Meter Assy	PIECE
	3	400700-T501-00000	路书总成 Roadbook Assembly	PIECE
	4	341400-T501-00001	仪表指示灯 Instrument Indicator	PIECE
	5	5013-05006-YH00	翻边衬套 $\phi 5.5 * \phi 8 * \phi 16 * 6.9$ Bushing, Flange $\phi 5.5 * \phi 8 * \phi 16 * 6.9$	PIECE
	6	420008-R201-000	工字胶圈 Ring, Rubber I-Shaped	PIECE
	7	5018-05515-SC00	平垫 $\phi 5$ Washer, Flat $\phi 5$	PIECE
	8	5008-05050-SC00	六角法兰面螺母M6 Bolt, Hex. Flange M6	PIECE
	9	5021-06013-BS00	内六角六角法兰面螺栓M6*13(盘14) Bolt, Hex. Flange M6x13 (Panhead 14)	PIECE
	10	5004-05025-BS01	内六角盘头螺钉M5*25 Screw, Inner Hex. Flat Head M5*25	PIECE
	11	420008-T501-00010	工字胶圈 $\phi 8 * \phi 11 * \phi 16 * (2+3.3+2)$ Ring, Rubber I-Shaped $\phi 8 * \phi 11 * \phi 16 * (2+3.3+2)$	PIECE
	12	5004-05016-BS02	内六角盘头螺钉M5*16 Screw, Inner Hex. Flat Head M5*16	PIECE
	13	5013-05005-YH00	翻边衬套 $\phi 5.5 * \phi 8 * \phi 16 * 5.4$ Bushing, Flange $\phi 5.5 * \phi 8 * \phi 16 * 5.4$	PIECE
	14	420008-T501-00009	工字胶圈 $\phi 8 * \phi 11 * \phi 16 * (2+1.8+2)$ Ring, Rubber I-Shaped $\phi 8 * \phi 11 * \phi 16 * (2+1.8+2)$	PIECE
	15	360042-T501-00000	路书支架 Road book holder	PIECE
	16			
	17			
	18			
	19			
	20			

F-20 Rear section of rear fender

PHOTO	NO.	Part CODE	Chinese/Chinese/English name and specification	UNIT	
	1	5007-08015-BS01	尾包安装螺栓M8*15 台阶5.5	Tailpack mounting bolts M8×15 台	PIECE
	2	5004-05013-BS01	内六角台阶螺钉M5*13, 台阶8*3.5	Stepping Screw, Inner Hex. M5*13, Stepping 8*3.5	PIECE
	3	390004-T501-00000	后尾盖	Cap, Rear Tail	PIECE
	4	341500-T501-00001	后位置灯总成	Rear position light assembly	PIECE
	5	420060-T501-00000	位置灯胶垫	Position light rubber pad	PIECE
	6	5005-05012-BS00	十字盘头螺钉M5*12	Screw, Cross-Shaped, Cup HeadM5*12	PIECE
	7	340200-T501-00001	尾灯总成	Tail light assembly	PIECE
	8	5005-05012-HX00	十字大盘头螺钉M5*12	Screw, Cross-Shaped, Cup Head M5*12	PIECE
	9	390020-T501-00000	后挡泥后段	Rear Part, Rear Fender	PIECE
	10	5021-08025-BS00	内六花六角法兰面螺栓M8*25 (盘16)	Screw, Cross-Shaped, Cup HeadM8x25 (Panhead 16)	PIECE
	11				
	12				
	13				
	14				
	15				
	16				
	17				
	18				
	19				
	20				

F-21 Cushion

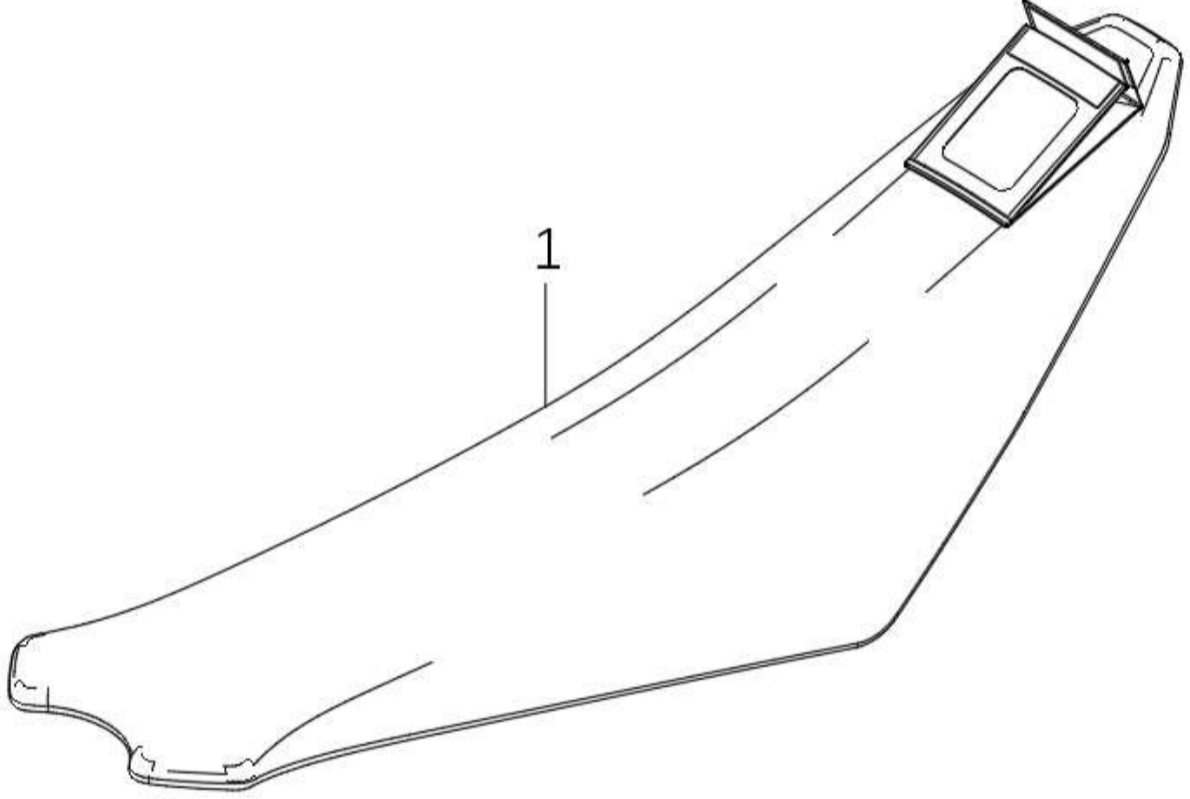
PHOTO	NO.	Part CODE	Chinese/Chinese/English name and specification	UNIT
	1	360700-T501-00000	座垫总成 Cushion	PIECE
	2			
	3			
	4			
	5			
	6			
	7			
	8			
	9			
	10			
	11			
	12			
	13			
	14			
	15			
	16			
	17			
	18			
	19			
	20			

F-22 Buffer

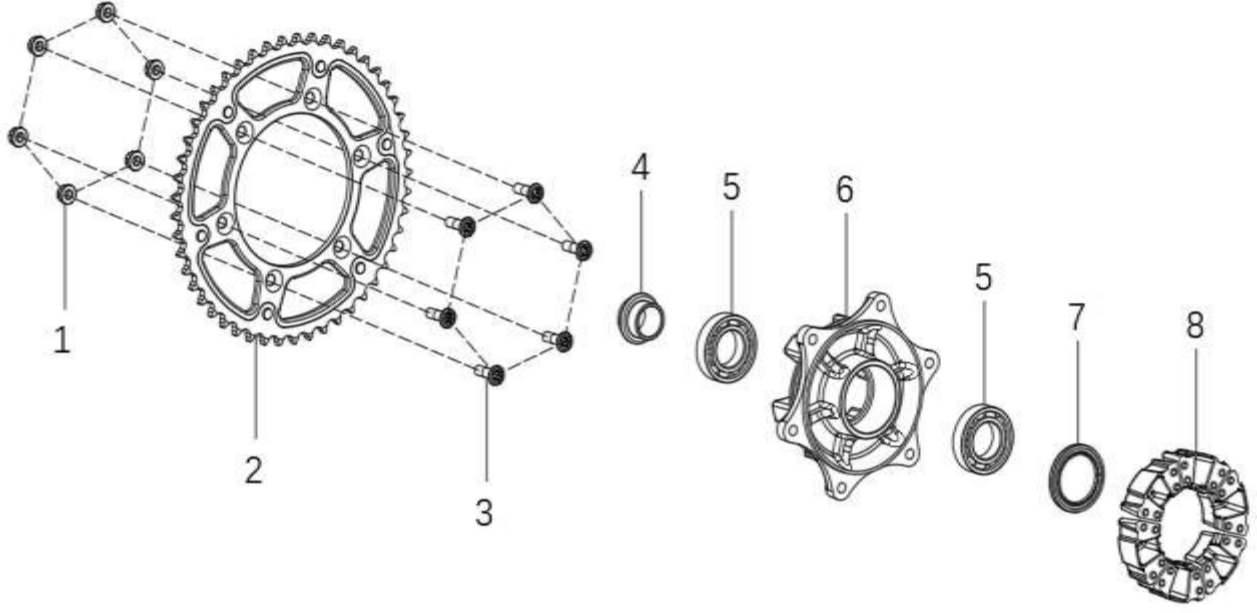
PHOTO	NO.	Part CODE	Chinese/Chinese/English name and specification		UNIT
	1	5008-08085-SC00	六角法兰面自锁螺母M8	Tapping Nut, Hex. FlangeM8	PIECE
	2	351902-T501-00000	大链轮	Large sprocket	PIECE
	3	5023-08027-BS00	内六花沉头螺钉M8*27	Screw, Inner Hex, Countersunk HeadM8x27	PIECE
	4	351901-T500-00000	T型衬套	T-shape bushing	PIECE
	5	5101-305513-BS0	轴承30*55*13	bearing 30*55*13	PIECE
	6	351900-T501-00000	缓冲体总成	Buffer assembly	PIECE
	7	5103-405504-000	油封 ϕ 40.9* ϕ 55*4	oil seal ϕ 40.9* ϕ 55*4	PIECE
	8	350022-T501-00000	后链轮缓冲胶	Rear Chain Wheel Buffer	PIECE
	9				
	10				
	11				
	12				
	13				
	14				
	15				
	16				
	17				
	18				
	19				
	20				

F-23 Air filter

PHOTO	NO.	Part CODE	Chinese/Chinese/English name and specification	UNIT	
	1	5021-06012-BS00	内六花六角法兰面螺栓M6*12(盘11)	Screw, Cross-Shaped, Cup HeadM6x12	PIECE
	2	320300-T501-00001	空滤器总成	Air filter assembly	PIECE
	3				
	4				
	5				
	6				
	7				
	8				
	9				
	10				
	11				
	12				
	13				
	14				
	15				
	16				
	17				
	18				
	19				
	20				

F-24 Headlights

PHOTO	NO.	Part CODE	Chinese/Chinese/English name and specification	UNIT	
	1	5021-05012-BS00	内六角六角法兰面螺栓M5*12	Screw, Cross-Shaped, Cup HeadM5x12	PIECE
	2	341700-T501-00000	前大灯总成-右	Headlight assembly-right	PIECE
	3	5021-06012-BS00	内六角六角法兰面螺栓M6*12(盘11)	Screw, Cross-Shaped, Cup HeadM6x12(Panhead 11)	PIECE
	4	341600-T501-00000	前大灯总成-左	Headlight assembly-left	PIECE
	5	330008-T501-00000	大灯控制模块	Headlight control module	PIECE
	6	341701-T501-00000	前大灯胶套-右	Front headlight rubber cover-right	PIECE
	7	341601-T501-00000	前大灯胶套-左	Front headlight rubber cover-left	PIECE
	8	390081-T501-00000	大灯装饰件	Headlight decoration piece	PIECE
	9	5004-06012-BS04	内六角台阶螺钉M6*12, 台阶8.5*3.5	Stepping Screw, Inner Hex. M6*12, Stepping 8.5*3.5	PIECE
	10				
	11				
	12				
	13				
	14				
	15				
	16				
	17				
	18				
	19				
	20				

F-25 Brake pedal assembly

PHOTO	NO.	Part CODE	Chinese/Chinese/English name and specification		UNIT
	1	5018-08210-BS00	平垫 $\phi 8.2 * \phi 26 * 1$	Flat pad $\phi 8.2 * \phi 26 * 1$	PIECE
	2	5103-131903-000	油封	oil seal	PIECE
	3	5007-08016-BS01	制动臂螺栓M8*16台阶 $\phi 13 * 18.2$	Brake Arm Bolt M8*16 stepping $\phi 13$	PIECE
	4	5012-01048-LB00	后制动回位簧 $\phi 1.6 * \phi 8 * 48$	Rear brake return spring $\phi 1.6 * \phi 8$	PIECE
	5	370010-T501-00000	刹车摇臂	Brake rocker arm	PIECE
	6	5021-05012-BS00	内六花六角法兰面螺栓M5*12	Screw, Cross-Shaped, Cup Head M5x12	PIECE
	7	350009-T501-00000	后制动踏板	Rear brake pedal	PIECE
	8				
	9				
	10				
	11				
	12				
	13				
	14				
	15				
	16				
	17				
	18				
	19				
	20				

F-26 Front shock absorber

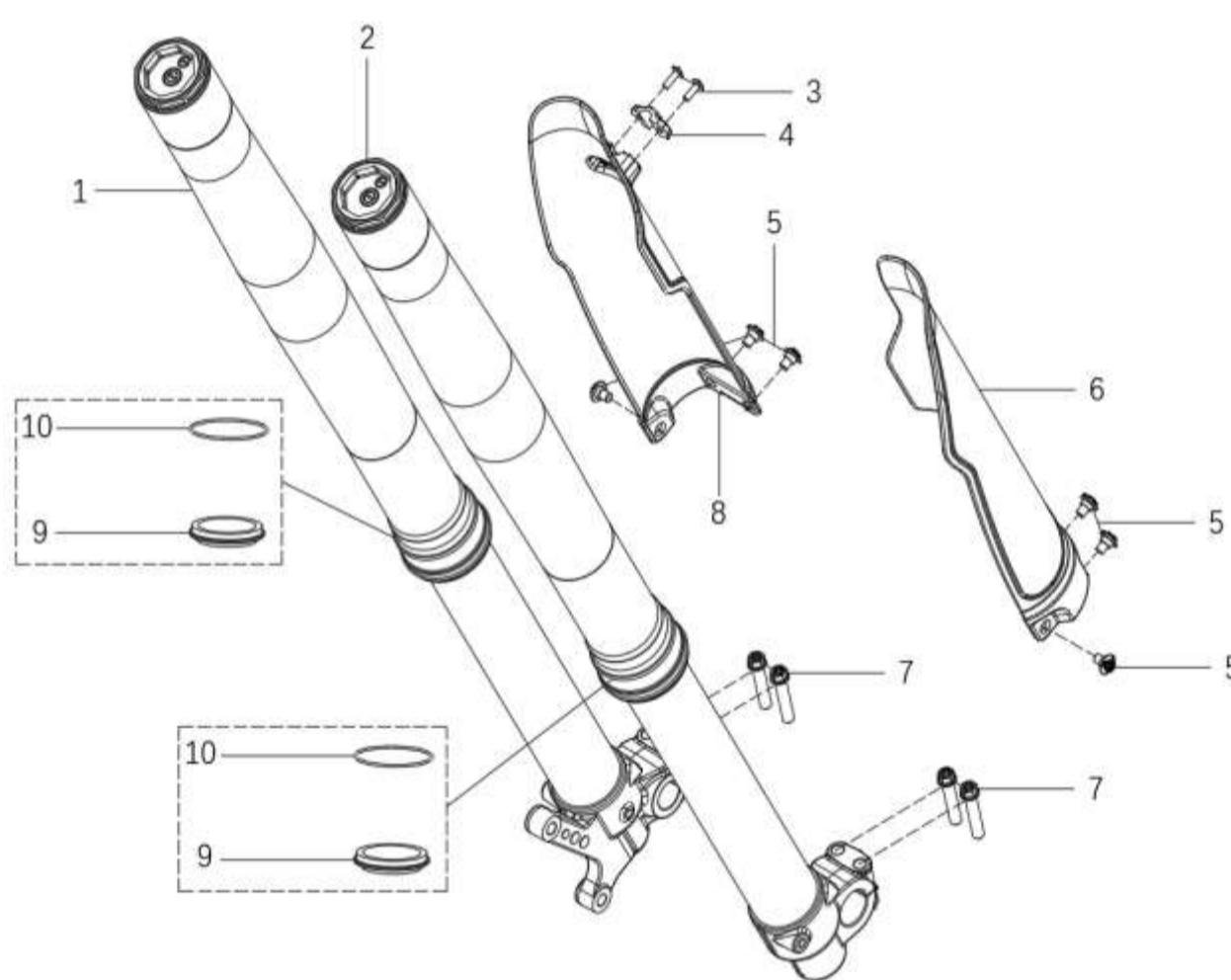
PHOTO	NO.	Part CODE	Chinese/Chinese/English name and specification	UNIT	
	1.1	371300-T501-00000	前减震器-左 (KYB减震)	Front shock absorber - left (KYB)	PIECE
	1.2	371300-T501-00001	前减震器-左 (渝安减震)	Front shock absorber - Left (Yu 'an shock absorber)	PIECE
	2.1	371400-T501-00000	前减震器-右 (KYB减震)	Front shock absorber - right (KYB shock absorber)	PIECE
	2.2	371400-T501-00001	前减震器-右 (渝安减震)	Front shock absorber -right (Yu 'an shock absorber)	PIECE
	3	5006-04012-SC00	自攻钉ST4. 8*12	Self Tapping ST4. 8*12	PIECE
	4	350035-T501-00000	前制动油管压板	Front brake tubing press plate	PIECE
	5	5004-06010-BS01	内六角台阶螺钉M6*10, 台阶8. 5*3. 5	Screw, Inner Hex. Flat Head M6*10, stepping 8. 5*3. 5	PIECE
	6	390062-T501-00000	前减震器装饰罩-右	Front shock absorber decoration cover - right	PIECE
	7	5021-08025-BS01	内六花六角法兰面螺栓M8*25 (盘13)	Screw, Cross-Shaped, Cup Head M8x25 (Panhead 13)	PIECE
	8	390055-T501-00000	前减震器装饰罩-左	Front shock absorber decoration cover - left	PIECE
	9	371302-T501-00000	前减震防尘封49*60. 2*11	Anti-dust seal , Front shock-absorbing 49*60. 2*11	PIECE
	10	5103-496010-000	前减震油封 $\phi 49 * \phi 60 * 10$	Oil seal, Front shock-absorbing $\phi 49 * \phi 60 * 10$	PIECE
	11				
	12				
	13				
	14				
	15				
	16				
17					
18					

F-27 Radiator

PHOTO	NO.	Part CODE	Chinese/Chinese/English name and specification		UNIT
	1	5021-05012-BS00	内六角六角法兰面螺栓M5*12	Screw, Cross-Shaped, Cup HeadM5x12	PIECE
	2	300302-T501-00000	散热器格栅-左	Radiator grille. - Left	PIECE
	3	300300-T501-00001	散热器总成-左	Radiator Assembly - Left	PIECE
	4	5021-06025-BS00	内六角六角法兰面螺栓M6*25(盘11)	Screw, Cross-Shaped, Cup HeadM6x25(Panhead 11)	PIECE
	5	5018-08020-BS00	平垫 $\phi 8 * \phi 20.5 * 2$	Washer, Flat $\phi 8 * \phi 20.5 * 2$	PIECE
	6	420056-T501-00000	水箱连接管	Water tank connection pipe	PIECE
	7	300400-T501-00001	散热器总成-右	Radiator Assembly - Right	PIECE
	8	300402-T501-00000	散热器格栅-右	Radiator grille. - Right	PIECE
	9	420020-T501-00001	进水管(右散热器)	inlet pipe (right radiator)	PIECE
	10	420021-T501-00000	出水管	outlet pipe	PIECE
	11	420700-T501-00000	储水壶排水管	Drain Pipe, Cooling Tank Assy	PIECE
	12	420027-T501-00000	泄压管	Pressure Relif Pipe	PIECE
	13	5004-06012-BS04	内六角台阶螺钉M6*12, 台阶8.5*3.5	Screw, Inner Hex. Flat HeadM6*12, stepping 8.5*3.5	PIECE
	14	420020-T501-00000	进水管(左散热器)	Inlet pipe (left radiator)	PIECE
	15	300200-T501-00001	储水壶总成	Cooling Tank Assy	PIECE
	16				
	17				
	18				
	19				
	20				

F-28 Oil cooler

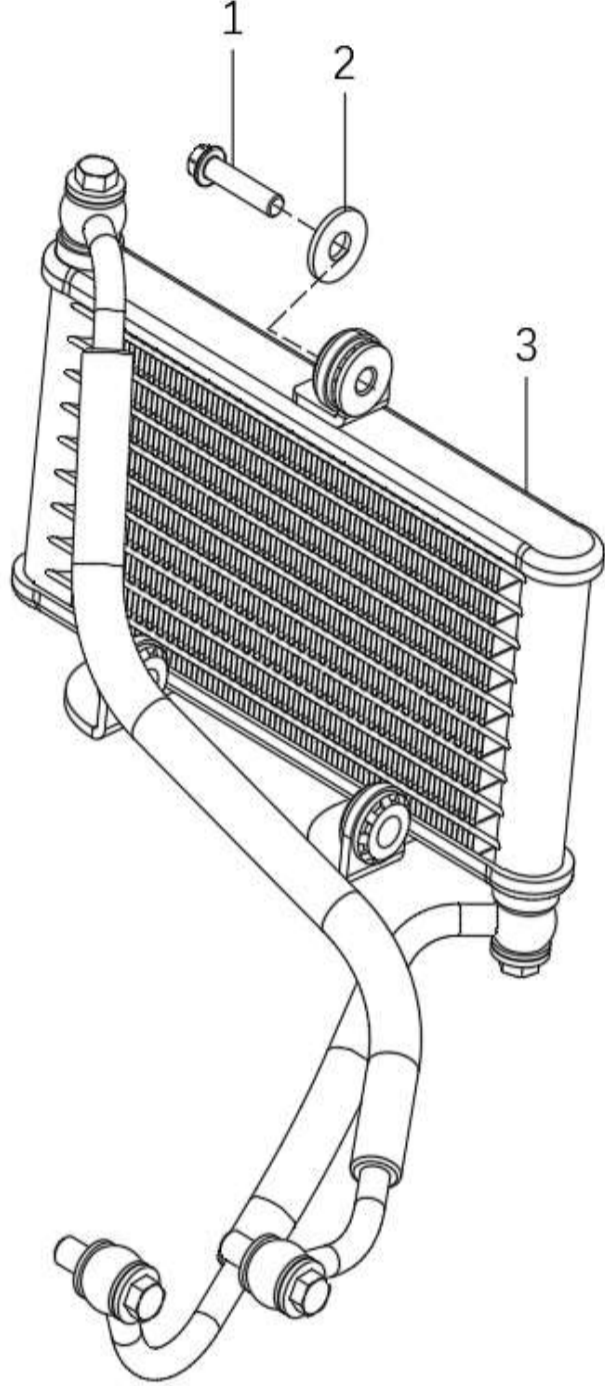
PHOTO	NO.	Part CODE	Chinese/Chinese/English name and specification	UNIT	
	1	5021-06025-BS00	内六花六角法兰面螺栓M6*25(盘11)	Screw, Cross-Shaped, Cup HeadM6x25(Panhead 11)	PIECE
	2	5018-06015-BS00	平垫 $\phi 6 * \phi 18 * 1.5$	Washer, Flat $\phi 6 * \phi 18 * 1.5$	PIECE
	3	311600-T501-00000	油冷器	Oil cooler	PIECE
	4				
	5				
	6				
	7				
	8				
	9				
	10				
	11				
	12				
	13				
	14				
	15				
	16				
	17				
	18				
	19				
	20				

F-29 Muffler

PHOTO	NO.	Part CODE	Chinese/Chinese/English name and specification	UNIT
	1	320001-T501-00000	消声器密封垫 Seal Gasket, Muffer Assy	PIECE
	2	5008-08165-SC00	盖形螺母M8*1.25*14 cap nut M8*1.25*14	PIECE
	3	320100-T501-00000	消声器前段总成 Exhausting Pipe, Muffler Assy	PIECE
	4	5012-01072-BS00	消声器弹簧 Muffler spring	PIECE
	5	320800-T501-00001	消声器中段总成 Muffler middle section assembly	PIECE
	6	420011-T501-00001	消声器安装工字胶 Installment Rubber, Muffler I-Shaped	PIECE
	7	5013-15019-YH00	翻边衬套15*8.5*20.5 Bushing, Flange 15*8.5*20.5	PIECE
	8	5018-08020-BS00	平垫 $\phi 8 * \phi 20.5 * 2$ Washer, Flat $\phi 8 * \phi 20.5 * 2$	PIECE
	9	5021-08035-BS00	内六花六角法兰面螺栓M8*35(盘13) Screw, Cross-Shaped, Cup Head M8x35(Panhead 13)	PIECE
	10	5021-08045-BS00	内六花六角法兰面螺栓M8*45(盘13) Screw, Cross-Shaped, Cup Head M8x45(Panhead 13)	PIECE
	11	5008-08085-SC00	六角法兰面自锁螺母M8*1.25 Tapping Nut, Hex. Flange M8*1.25	PIECE
	12	320200-T501-00000	消声器后段总成 Rear Part, Muffler Assy	PIECE
	13	310900-T500-00000	氧传感器 oxygen sensor	PIECE
	14			
	15			
	16			
	17			
	18			
	19			
	20			

F-30 Windshield and fuel tank trim

PHOTO	NO.	Part CODE	Chinese/Chinese/English name and specification	UNIT
	1	420008-T501-00007	工字胶圈 Ring, Rubber I-Shaped	PIECE
	2	5007-06021-HX00	1/4转快锁式螺栓 1/4Turn fast locking bolt	PIECE
	3	5012-07024-FH00	弹出弹簧 $\phi 7.63 * \phi 11.43 * 24.13$ Pop-up spring $\phi 7.63 * \phi 11.43 * 24.13$	PIECE
	4	5018-07035-BS00	杯形垫圈 $\phi 7 * \phi 24 * 3.5$ cup washer $\phi 7 * \phi 24 * 3.5$	PIECE
	5	5020-05405-BS00	挡圈 $\phi 5.4 * \phi 12.5 * 0.5$ Collar $\phi 5.4 * \phi 12.5 * 0.5$	PIECE
	6	390028-T501-00000	前挡风 front windshield	PIECE
	7	5004-05013-BS01	内六角台阶螺钉M5*13, 台阶8*3.5 Screw, Inner Hex. Flat HeadM5*13, 台阶8*3.5	PIECE
	8	5018-08007-BS00	平垫(尼龙垫片) Flat pad (nylon)	PIECE
	9	420024-R100-000	橡胶螺母 Rubber nut	PIECE
	10	5007-06016-HX00	1/4转快锁式螺栓 1/4Turn fast locking bolt	PIECE
	11	5018-06520-BS00	平垫 $\phi 6.5 * \phi 20 * 2$ Washer, Flat $\phi 6.5 * \phi 20 * 2$	PIECE
	12	390076-T501-00000	油箱前装饰件-左 Tank front decoration piece - left	PIECE
	13	390077-T501-00000	油箱前装饰件-右 Tank front decoration piece - right	PIECE
	14			
	15			
	16			
	17			
	18			
	19			
	20			

F-31 Braking system

PHOTO	NO.	Part CODE	Chinese/Chinese/English name and specification	UNIT
	1	350001-P302-00001	过油螺栓M10*1.25*22 Oil BoltM10*1.25*22	PIECE
	2	350002-R100-000	铜垫圈 $\phi 10 * \phi 15 * 1.5$ copper washer	PIECE
	3	5005-05012-BS00	十字盘头螺钉M5*12 Screw, Cross-Shaped, Cup HeadM5*12	PIECE
	4	350025-T501-00001	油管卡子 Oil pipe clip	PIECE
	5	350800-T501-00000	制动油管1 Brake oil pipe 1	PIECE
	6	350500-T501-00000	后制动卡钳总成 Rear brake caliper assembly	PIECE
	7	350501-T501-00000	后刹车片 Rear brake pad	PIECE
	8	5018-08012-BS00	平垫 $\phi 8 * \phi 16 * 1$ washer, flat $\phi 8 * \phi 16 * 1$	PIECE
	9	350034-T501-00000	后制动泵拨叉 Rear brake pump fork	PIECE
	10	350033-T501-00000	后制动泵销轴 Rear brake pump pin	PIECE
	11	5015-01016-SC00	开口销1.2*16 Pin, Split 1.2*16	PIECE
	12	5004-06016-BS04	内六角盘头螺钉M6*16 Screw, Inner Hex. Flat HeadM6*16	PIECE
	13	350600-T501-00000	后制动泵总成 Rear brake pump assembly	PIECE
	14	351000-T501-00000	制动油管3 Brake oil pipe 3	PIECE
	15	5021-08035-BS00	内六花六角法兰面螺栓M8*35(盘13) Screw, Cross-Shaped, Cup HeadM8x35(Panhead 13)	PIECE
	16	350301-T501-00000	前刹车片 Front brake pads	PIECE
	17	352600-T501-00000	前制动卡钳总成 Front brake caliper assembly	PIECE
	18	390080-T501-00000	后制动卡钳装饰件 Rear brake caliper decoration piece	PIECE
	19	5021-06013-BS00	内六花六角法兰面螺栓M6*13(盘14) Screw, Cross-Shaped, Cup HeadM6x13(Panhead 14)	PIECE
	20	390079-T501-00000	后碟刹装饰件 Rear disc brake decoration piece	PIECE

F-31 Braking system-1

PHOTO	NO.	Part CODE	Chinese/Chinese/English name and specification	UNIT	
	21	350036-T501-00000	前卡钳支架 (KYB减震使用)	Front caliper bracket (for KYB s	PIECE
	22	350602-T501-00000	后制动泵油杯盖	oil cup cover, Rear brake pump	PIECE
	23	350700-T501-00000	后制动开关	Rear brake switch	PIECE
	24				
	25				
	26				
	27				
	28				
	29				
	30				
	31				
	32				
	33				
	34				
	35				
	36				
	37				
	38				
	39				
	40				

F-32 Front pedal

PHOTO	NO.	Part CODE	Chinese/Chinese/English name and specification	UNIT
	1	370300-T501-00000	前脚蹬-左 Front pedal. -Left	PIECE
	2	370014-T501-00001	销 $\phi 10*44.5$ Pin $\phi 10*44.5$	PIECE
	3	370400-T501-00000	前脚蹬-右 Front pedal. - Right	PIECE
	4	5015-01016-SC00	开口销1.2*16 Pin, Split 1.2*16	PIECE
	5	370003-T501-00000	脚蹬扭簧-左 Foot twist spring. - Left	PIECE
	6	370004-T501-00000	脚蹬扭簧-右 Foot twist spring. - Right	PIECE
	7	5018-10515-BS00	平垫 $\phi 10.5*\phi 20*1.5$ washer flat $\phi 10.5*\phi 20*1.5$	PIECE
	8			
	9			
	10			
	11			
	12			
	13			
	14			
	15			
	16			
	17			
	18			
	19			
	20			

F-33 Hood bracket

PHOTO	NO.	Part CODE	Chinese/Chinese/English name and specification	UNIT
	1	5027-06012-BS00	橡胶螺栓M6*12 Rubber bolt M6*12	PIECE
	2	5008-06070-SC00	六角法兰面自锁螺母M6 Tapping Nut, Hex. FlangeM6	PIECE
	3	5021-06012-BS00	内六花六角法兰面螺栓M6*12(盘11) Screw, Cross-Shaped, Cup HeadM6x12(Panhead 11)	PIECE
	4	5008-06070-SC00	六角法兰面螺母M6 Nut, Hex. FlangeM6	PIECE
	5	360043-T501-00000	头罩支架 Head cover bracket	PIECE
	6	5021-08050-BS01	内六花六角法兰面螺栓M8*50(盘16) Screw, Cross-Shaped, Cup HeadM8x50(Panhead 16)	PIECE
	7	5008-08085-SC00	六角法兰面自锁螺母M8*1.25*8.5*14 Tapping Nut, Hex. FlangeM8*1.25*8.5*14	PIECE
	8			
	9			
	10			
	11			
	12			
	13			
	14			
	15			
	16			
	17			
	18			
	19			
	20			

QTY	PRICE (excluding tax)
	Upper Connecting Plate and steering column
	Upper Connecting Plate and shock
	Upper Connecting Plate and shock
	Steering column locking

QTY	PRICE (excluding +tax)
	前轮轴和平叉轴 螺母
	链条调节
	链条调节
	链条护卡
	导链器与平叉
	导链器与平叉
	导链器与平叉

QTY	PRICE (excluding tax)

QTY	PRICE (excluding tax)

QTY	PRICE (excluding tax)

QTY	PRICE (excluding tax)

PRICE	
QTY	(excluding tax)

QTY	PRICE (excluding tax)

QTY	PRICE (excluding tax)
3	

QTY	PRICE (excluding tax)
10	
6	
10	
10	
10	
10	
3	
10	

QTY	PRICE (excluding tax)
6	
3	

QTY	PRICE (excluding tax)

QTY	PRICE (excluding tax)

QTY	PRICE (excluding tax)

QTY	PRICE (excluding tax)
2	
1	
2	
2	
6	
6	

QTY	PRICE (excluding tax)

PRICE	
QTY	(excluding tax)

PRICE	
QTY	(excluding tax)

QTY	PRICE (excluding tax)

QTY	PRICE (excluding tax)